

BATH/
CO/

the smart
collection



vcbc



Durability.

We use a high-performance modern acrylic for all our benchtops to ensure a hard but smooth finish that is water-, scratch-, heat- and stain-resistant. Its durable, non-porous surface makes it easy to maintain and very hygienic. You will enjoy a quality material and finish with the looks to create a beautiful bathroom.



Superior Paint Finish.

The VCBC flawless cabinetry finish is achieved through our high-tech paint layering process, where every panel is painted and heated at least five times before being assembled into the unit of your choice. Five times harder than lacquer-painted surfaces, it is the only process of its kind in Australasia and comes with a five-year warranty.



Colour Range.

Our contemporary colour range, regularly reviewed and renewed to keep ahead of the latest aesthetics in interior design, ensures you have the perfect options to create a range of looks. Our naturals, greys and blacks are the most popular, but people wanting something more dynamic can select from our carefully chosen bright colours to make your interior absolutely memorable.



Smooth Touch.

Experience the quality and finish of VCBC products in person. We invite you to visit one of our showrooms to touch and discover a surface so impeccably smooth, you could be forgiven for thinking it was glass.



Made in New Zealand.



Our Story

In 1950, we started a family business. Our special blend of (relatively) youthful exuberance and (relatively) sensible experience has ensured the company has flourished. We've outlived walkshorts, survived stubbies, prevailed over polaroids and taken up new technology.

From an era when one-bathroom houses were the norm, Bath Co (previously Smail & Co) has maintained its position at the leading edge of the bathroom industry.

Over the decades, innovation has seen us adapt, and just like our customers' needs and wants, we'll continue to evolve.

When it comes to the manufacture and importation of bathroom products, we know our stuff. Our VCBC collection is made here in New Zealand, using the latest technology to produce pieces of flawless quality, finish and durability.

We create contemporary pieces that remain timeless and which suit a wide range of personalities and budgets. Most of the ceramics and accessories that complement our collection are sourced from design houses in China – where leading design is matched by unrivalled standards of craftsmanship and quality.

With showrooms in Auckland and Christchurch, robust inter-island (and inter-generational) input provides you with a stunning range that'll look great, suit your lifestyle and last at least as long as the company has.

Here's to the future of a committed New Zealand company, and here's to the next generation of family involvement.

Enjoy browsing our Smart Collection and don't hesitate to contact us. We'd love to talk to you.



Bath Co Managing Director — Mike Smail

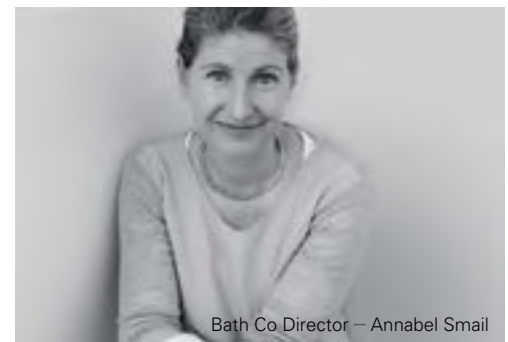

Bath Co Director — Annabel Smail





the finish:

DRIFTWOOD

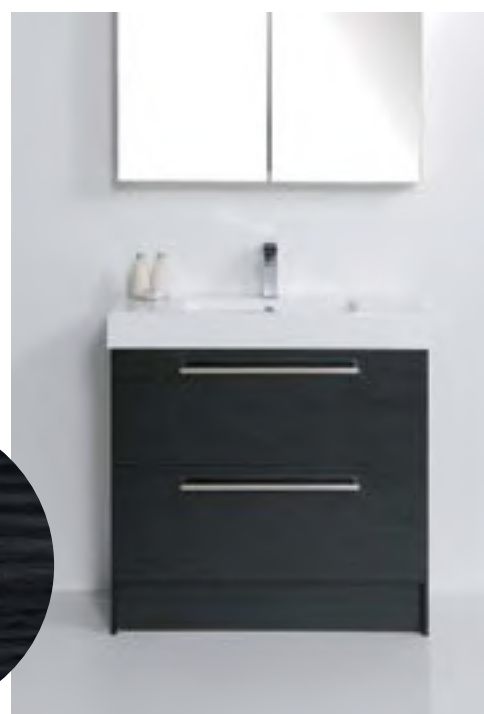

the finish:

***CHARRED
OAK***



**Stay neutral for
classic elegance.**

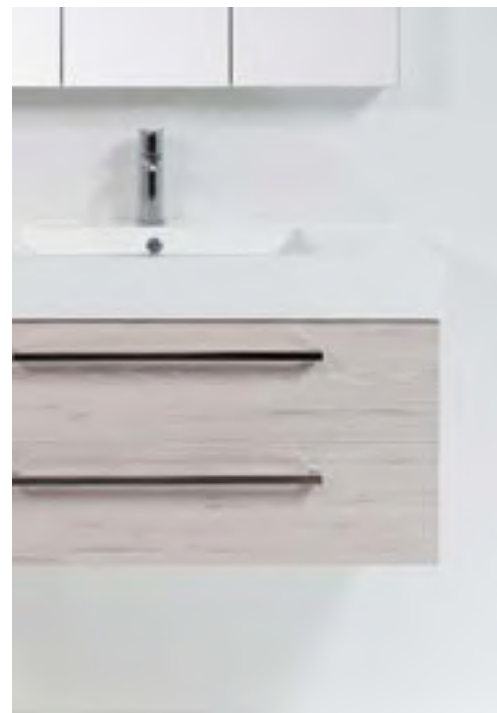

**Statement black
brings a bold
masculine edge.**





Brightness and freshness with Scandi minimalism.



the finish:

***NORDIC
ASH***



the finish:

***SOUTHERN
OAK***

the finish:

***MANHATTAN
ELM***



Your very own Soho hotel sanctuary.



Stick to neutral tones, but in a warm, inviting glow.

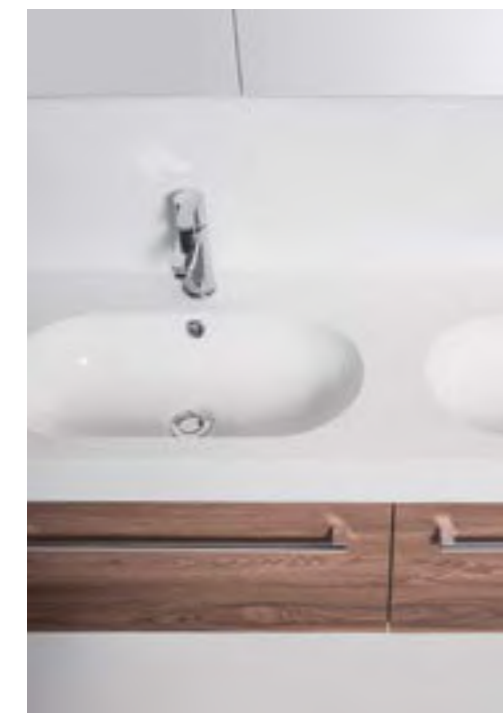

Contents

- 7 Vanities**
- 7 Mix & Match
- 24 Sharp
- 26 Dish
- 28 Paris
- 30 Fit
- 30 Ice
- 30 Space
- 32 Tall Cabinets**
- 33 Mirror Units**
- 36 Wash Basins**
- 38 Tapware**
- 40 Shower Sets**
- 41 Baths**
- 42 ClearStone Baths
- 44 Natural Stone Baths
- 45 Acrylic Baths
- 46 Skirt Baths
- 46 Whirlpool Baths
- 48 Shower Baths
- 50 Non-Stock Baths
- 51 Showers**
- 52 Lucca Quadrant Sliding Showers
- 53 Lucca Infold Showers
- 54 Lucca Alcove Shower
- 55 Lucca Showers
- 56 Assisi Showers
- 58 Central Showers
- 60 Acrylic Shower Trays**
- 62 Shower Components**
- 64 Accessories**
- 65 Onda Toilets
- 66 Fine Angled Toilets
- 67 Fine Round Toilets
- 68 In-wall Cisterns
- 69 Technicals**



Mix & Match Vanity Range

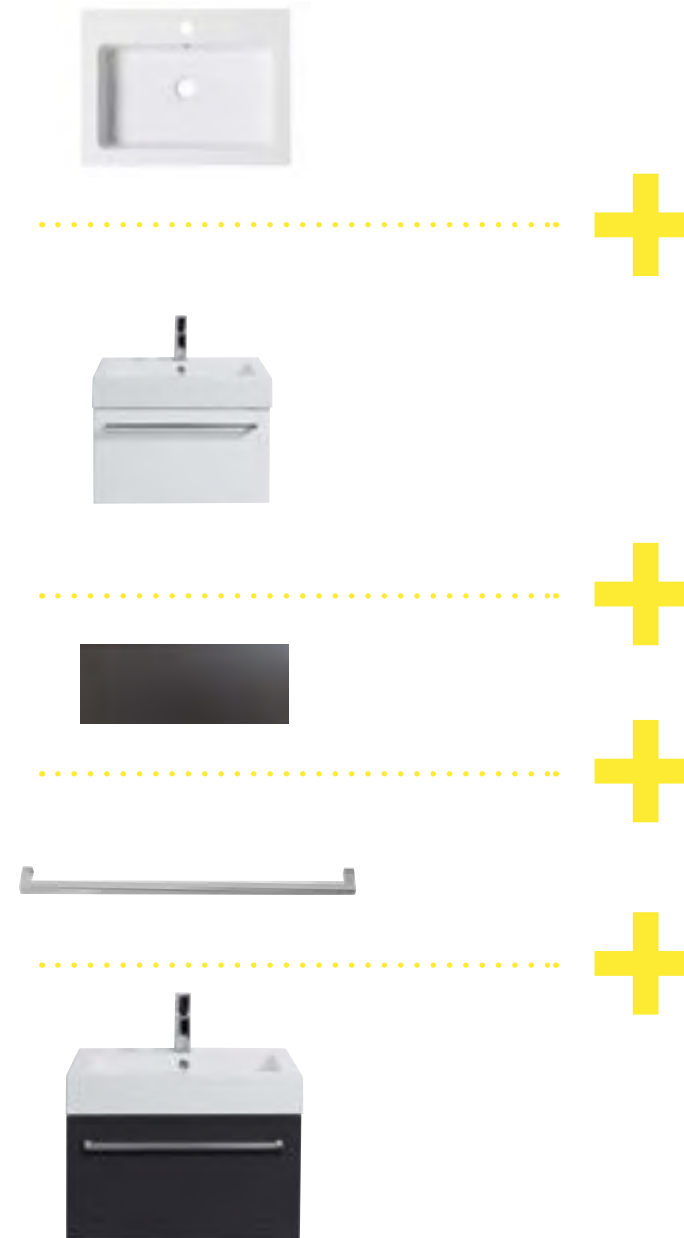

**CLEANER
LIVING,
CLEVER
DESIGN.**

We know choosing the right vanity can seem tricky, but here are some things to think about and some tips to help make the decision easier.

WALL-HUNG OR FLOOR UNIT?

The size of your bathroom and how many people will be using it will affect your decision. How much storage do you require? Guest bathrooms usually don't require a great deal of storage space, and a family bathroom will benefit from having lots of cupboards and drawers. Wall-hung units tend to make a bathroom look larger and are easier to maintain.

SINGLE OR DOUBLE BOWL?

Consider the amount of space you want on the vanity top, the size of your bathroom and who will be using it, to determine whether you want one or two basins.

WHICH STYLE?

When thinking of style, keep in mind the style of your home and your personality. We have great finish options available - a special white painted finish or stunning timber effect melamine. Also, give some careful thought to the style of bowl you want in your vanity.

POLYMARBLE OR CHINA?

Polymarble is a composite mixture of polyurethane resin with a gel coat surface, using various fillers to achieve strength and rigidity. Polymarble is a durable, solid and attractive product that has been used in the manufacturing of bathroom products for many years. Our polymarble tops are Fresh, Paris and Splash.

China tops are composed of ceramic materials fired at high temperature to form a non-porous

body, having exposed surfaces coated with ceramic glaze fused to the body. This is used to form a number of bathroom fixtures such as toilets, bidets and lavatory sinks. China sinks are susceptible to damage from heavy impact due to the firing process. Due to the firing process - china shrinks up to 10%. This means that every top is unique and will have small flaws including slight warping. Our china tops are Zara and Space.



600 Vanities

mix&match

Choose a top, add a cabinet, pick a finish and complete the look with handles.



Splash Basin (Polymarble)
SP 600mm

Zara Basin (China)
Z 600mm



\$940

60D2FL
600mm, 2 Drawers, Single Bowl, Floor-standing, White / Melamine
W600 x H820 x D450
Splash: W600 x H900 x D455



\$685

60
600mm, 2 Doors, Single Bowl, Floor-standing, White / Melamine
W600 x H820 x D450
Splash: W600 x H900 x D455



\$660

60DWH
600mm, 1 Drawer, Single Bowl, Wall-hung, White / Melamine
W600 x H470 x D450
Splash: W600 x H425 x D450



\$850

60D2WH
600mm, 2 Drawers, Single Bowl, Wall-hung, White / Melamine
W600 x H470 x D450
Splash: W600 x H550 x D450

NEW



MCO
Charred Oak

MDF
Driftwood

MME
Manhattan Elm

MNA
Nordic Ash

MSO
Southern Oak

No Code
White

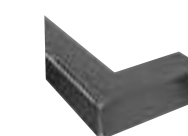

H1 Box Handle

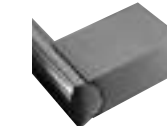

H2 Semi Handle

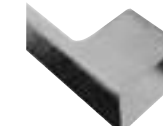

H4 Mini Semi Handle



HL L Handle

NB: Price includes a top, cabinet and handle (excludes tapware & accessories). *No soft-close drawers. **Measurements do not include the height or depth of the top.

750 Vanities

A customised vanity to suit your lifestyle and personality.

mix&match



Zara Basin (China)
Z 750mm



Fresh Basin (Polymarble)
FR 750mm

\$975

75D2FL
750mm,
2 Drawers,
Floor-standing,
White / Melamine
W750 x H820 x D467

Black handle additional cost + \$84



\$890

75
750mm, 1 Door,
2 Drawers*,
Floor-standing,
White / Melamine
W750 x H820 x D467



\$710

75DWH
750mm, 1 Drawer,
Wall-hung,
White / Melamine
W750 x H470 x D467

Black handle additional cost + \$42



\$850

75D2WH
750mm, 2 Drawers,
Wall-hung, White / Melamine
W750 x H470 x D467

Black handle additional cost + \$84



\$885

75D2WHX
750mm, 2 Drawers,
Extra deep,
Wall-hung, White / Melamine
W750 x H650** x D467

Black handle additional cost + \$84



NEW

NEW

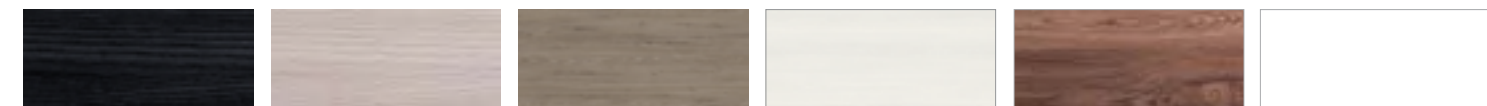

MCO
Charred Oak

MDF
Driftwood

MME
Manhattan Elm

MNA
Nordic Ash

MSO
Southern Oak

No Code
White

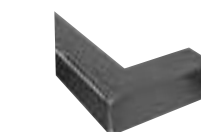

H1 Box Handle

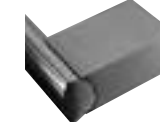

H2 Semi Handle

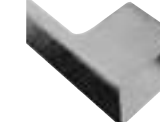

H4 Mini Semi Handle



HL L Handle



HBK Black L Handle
(Additional cost for this option)

NB: Price includes a top, cabinet and handle (excludes tapware & accessories).
*No soft-close drawers. **Measurements do not include the height or depth of the top.

900 Vanities

A wall-hung unit creates a sense of space.



mix&match

ZARA Z90D2WHXMME



Splash Basin (Polymarble)
SP 900mm



Zara Basin (China)
Z 900mm



Fresh Basin (Polymarble)
FR 900mm

\$1100

90D2FL
900mm, 2 Drawers, Floor-standing, White / Melamine W900 x H820 x D467
Splash: W900 x H900 x D450
Black handle additional cost + \$84



\$935

90
900mm, 2 Doors, 2 Drawers*, Floor-standing, White / Melamine W900 x H820 x D467
Splash: W900 x H900 x D450



\$890

90WH
900mm, 2 Doors, 1 Drawer*, Wall-hung, White / Melamine W900 x H470 x D467
Splash: W900 x H425 x D450



\$820

90DWH
900mm, 1 Drawer, Wall-hung, White / Melamine W900 x H470 x D467
Splash: W900 x H425 x D450
Black handle additional cost + \$42



\$965

90D2WH
900mm, 2 Drawers, Wall-hung, White / Melamine W900 x H470 x D467
Splash: W900 x H550 x D455
Black handle additional cost + \$84



\$999

90D2WHX
900mm, 2 Drawers, Extra deep, Wall-hung, White / Melamine W900 x H650** x D467
Splash: W900 x H650** x D467
Black handle additional cost + \$84



MCO Charred Oak **MDF** Driftwood **MME** Manhattan Elm **MNA** Nordic Ash **MSO** Southern Oak **No Code** White

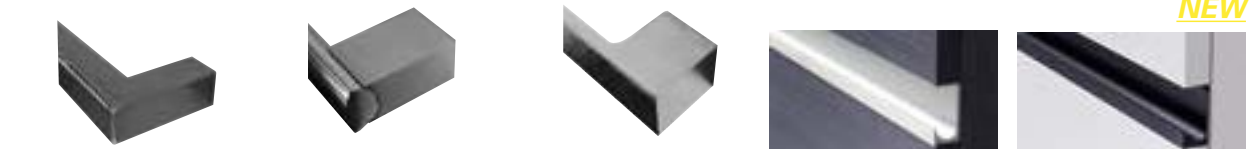

H1 Box Handle **H2** Semi Handle **H4** Mini Semi Handle **HL** L Handle **HBK** Black L Handle
(Additional cost for this option)

NB: Price includes a top, cabinet and handle (excludes tapware & accessories).
*No soft-close drawers. **Measurement do not include the height or depth of the top.

1000 Vanities

Satisfy your storage needs with generous deep floor units.

mix&match



ZARA Z100D2FLMSO



Zara Basin (China)
Z 1000mm

\$1190

100D2FL
1000mm, 2 Drawers,
Floor-standing, White / Melamine
W1000 x H820 x D464



\$1130

100
1000mm, 2 Doors, 2 Drawers*,
Floor-standing, White / Melamine
W1000 x H820 x D464



\$1050

100WH
1000mm, 2 Doors, 1 Drawer*,
Wall-hung, White / Melamine
W1000 x H470 x D464



\$960

100DWH
1000mm, 1 Drawer, Wall-hung,
White / Melamine W1000 x H470 x D464



\$1125

100D2WH
1000mm, 2 Drawers, Wall-hung,
White / Melamine W1000 x H470 x D464



NEW



MCO
Charred Oak

MDF
Driftwood

MME
Manhattan Elm

MNA
Nordic Ash

MSO
Southern Oak

No Code
White

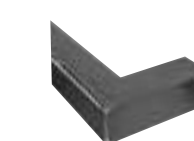

H1 Box Handle

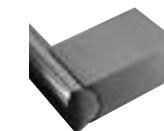

H2 Semi Handle

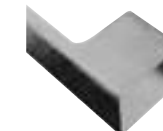

H4 Mini Semi Handle



HL L Handle

NB: Price includes a top, cabinet and handle (excludes tapware & accessories). *No soft-close drawers.

1200 Vanities

SINGLE BOWL

Extra deep drawers house all your daily essentials and more.

mix&match



Splash Basin (Polymarble)
SP 1200mm



Zara Basin (China)
Z 1200mm



Fresh Basin (Polymarble)
FR 1200mm

\$1365

120D2FLSB
1200mm, 2 Drawers,
Floor-standing, White/Melamine
W1200 x H820 x D450
Splash: W1200 x H900 x D450
Black handle additional cost + \$84



\$1290

120
1200mm, 2 Doors, 4 Drawers*,
Floor-standing, White/Melamine
W1200 x H820 x D450
Splash: W1200 x H900 x D450



\$1130

120WH
1200mm, 2 Doors, 2 Drawers*,
Wall-hung, White/Melamine
W1200 x H470 x D450
Splash: W1200 x H425 x D450



\$1085

120DWH
1200mm, 1 Drawer,
Wall-hung, White/Melamine
W1200 x H470 x D450
Splash: W1200 x H425 x D450
Black handle additional cost + \$42



\$1270

120D2WHSB
1200mm, 2 Drawers,
Wall-hung, White/Melamine
W1200 x H470 x D450
Splash: W1200 x H425 x D450
Black handle additional cost + \$84



\$1295

120D2WHX
1200mm, 2 Drawers, Extra deep,
Wall-hung, White/Melamine
W1200 x H650** x D467
Splash: W1200 x H650** x D467
Black handle additional cost + \$84

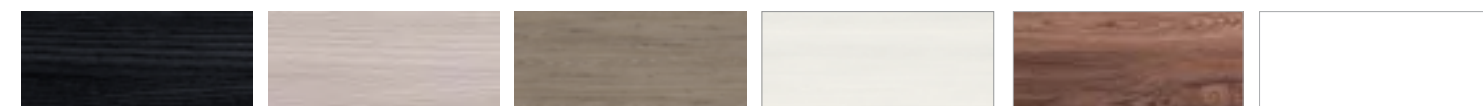

MCO
Charred Oak

MDF
Driftwood

MME
Manhattan Elm

MNA
Nordic Ash

MSO
Southern Oak

No Code
White

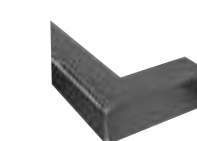

H1 Box Handle

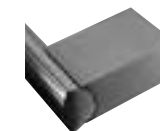

H2 Semi Handle

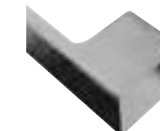

H4 Mini Semi Handle



HL L Handle



HBK Black L Handle
(Additional cost for this option)

NB: Price includes a top, cabinet and handle (excludes tapware & accessories).
*No soft-close drawers. **Measurement do not include the height or depth of the top.

1200 Vanities

DOUBLE BOWL

mix&match



Splash out on individual sinks and drawers.

SPLASH SP1202D2WHMDF



Zara Basin (China)
Z 1200mm, Double Bowl



Splash Basin (Polymarble)
SP 1200mm, Double Bowl



\$1550

120D4FLDB
1200mm, 4 Drawers,
Double Bowl, Floor-standing
White / Melamine
W1200 x H820 x D450
Splash: W1200 x H900 x D450
Black handle additional cost + \$168



\$1240

1202D2WHDB
1200mm, 2 Drawers,
Double Bowl, Wall-hung
White / Melamine
W1200 x H450 x D450
Splash: W1200 x H425 x D450
Black handle additional cost + \$84



MCO Charred Oak **MDF** Driftwood **MME** Manhattan Elm **MNA** Nordic Ash **MSO** Southern Oak **No Code** White

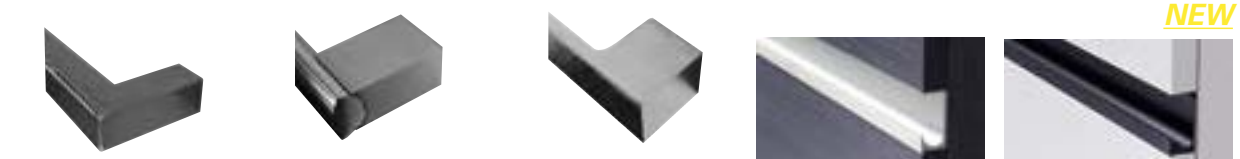

H1 Box Handle **H2** Semi Handle **H4** Mini Semi Handle **HL** L Handle **HBK** Black L Handle (Additional cost for this option)

NB: Price includes a top, cabinet and handle (excludes tapware & accessories).

1500 Vanities



Round-edged basins soften the look of double sinks.

mix&match



Zara Basin (China)
Z 1500mm (Limited stock)



Zara Basin (China)
Z 1500mm, Double Bowl (Limited stock)



Fresh Basin (Polymarble)
FR 1500mm, Double Bowl



Splash Basin (Polymarble)
SP 1500mm, Double Bowl

SINGLE BOWL UNIT



\$1695

150DWH
(Zara Only)
1500mm, 2 Drawers, Single Bowl,
Wall-hung, White / Melamine
W1510 x H450 x D450

DOUBLE BOWL UNITS



FROM \$1950

150D4FLDB
Zara **\$2830** Fresh **\$1950**
1500mm, 4 Drawers, Double Bowl,
Floor-standing, White / Melamine
W1510 x H820 x D450
Splash: **\$1950**
W1510 x H900 x D450



FROM \$1500

1502DWH
Zara **\$2190** Fresh **\$1500**
1500mm, 2 Drawers,
Side by Side, Double Bowl,
Wall-hung, White / Melamine
W1510 x H450 x D450
Splash: **\$1500**
W1510 x H425 x D450

NEW

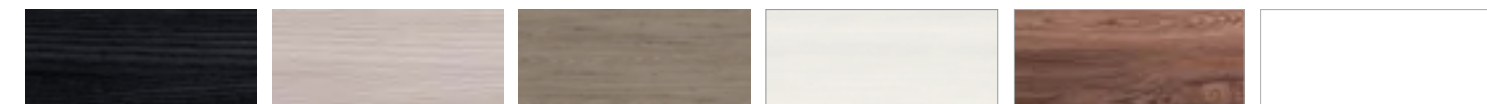

MCO
Charred Oak

MDF
Driftwood

MME
Manhattan Elm

MNA
Nordic Ash

MSO
Southern Oak

No Code
White

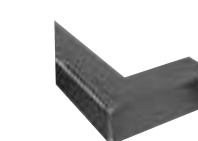

H1 Box Handle

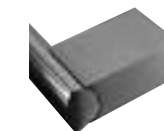

H2 Semi Handle

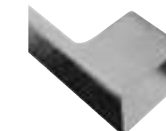

H4 Mini Semi Handle



HL L Handle

NB: Price includes a top, cabinet and handle (excludes tapware & accessories).

1800 Vanities

mix&match



Double units blend seamlessly with the right colour and design.



Splash Basin (Polymarble)
SP 1800mm, Double Bowl



\$2075

180D4FLDB
1800mm, 4 Drawers, Double Bowl, Floor-standing, White / Melamine
W1800 x H900 x D450



\$1620

180D2SWHDB
1800mm, 2 Drawers, Side by Side, Double Bowl, Wall-hung, White / Melamine
W1800 x H450 x D450



NEW

MCO Charred Oak **MDF** Driftwood **MME** Manhattan Elm **MNA** Nordic Ash **MSO** Southern Oak **No Code** White

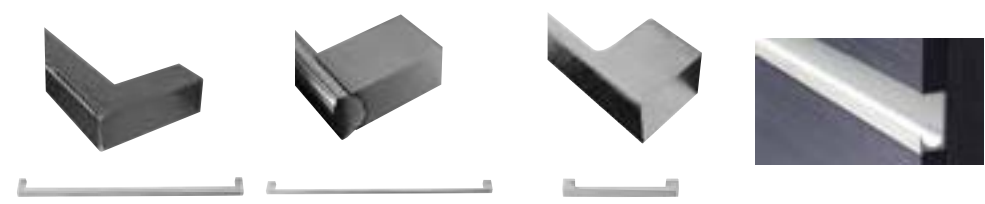

H1 Box Handle **H2** Semi Handle **H4** Mini Semi Handle **HL** L Handle

NB: Price includes a top, cabinet and handle (excludes tapware & accessories).

Sharp Vanities

NEW



Bevelled ceramic top for the modern European look.



SHARP SH70D2WH with Black Aluminium Rail



SHARP SH90D2WHMCO with Aluminium Rail



Sharp Basin (Ceramic)
SH 700, 900, 1040, 1200mm

\$935

70D2WH 690mm, 2 Drawers, Wall-hung, White / Melamine
W690 x H520 x D476



\$1010

90D2WH 885mm, 2 Drawers, Wall-hung, White / Melamine
W885 x H520 x D476



\$1105

104D2WH 1040mm, 2 Drawers, Wall-hung, White / Melamine
W1040 x H520 x D476



\$1375

120D2WH 1200mm, 2 Drawers, Wall-hung, White / Melamine
W1200 x H520 x D476



NEW



MCO
Charred Oak

MDF
Driftwood

MME
Manhattan Elm

MNA
Nordic Ash

MSO
Southern Oak

No Code
White

HANDLE DETAIL OPTIONS

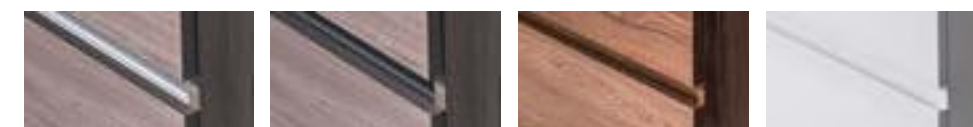

RAL
Aluminium Rail

RALBK
Black Aluminium Rail

RM
Melamine Finish
(Colour match with unit)

RW
White Paint Finish
(Only with white unit)

NB: Price includes a top, cabinet and handle (excludes tapware & accessories).

Dish Vanities **NEW**



Slim, functional and with a modern touch.



DISH DS90DWH



DISH DS120D2DBWHMSO



DISH DS120D2DBWHMSO



Dish Basin (Polymarble)
DS 900mm



Dish Basin (Polymarble)
DS 1200mm, Double Bowl

\$695



90DWH 900mm, 1 Drawer, Wall-hung, White / Melamine W900 x H325 x D400
Black handle additional cost + \$42

\$1240



120D2DBWH 1200mm, 2 Drawers, Side by side, Wall-hung, Double Bowl, White / Melamine W1200 x H325 x D400
Black handle additional cost + \$84



MCO Charred Oak **MDF** Driftwood **MME** Manhattan Elm **MNA** Nordic Ash **MSO** Southern Oak **No Code** White



H1 Box Handle **H2** Semi Handle **HL** L Handle **HBK** Black L Handle (Additional cost for this option)

NB: Price includes a top, cabinet and handle (excludes tapware & accessories).

Paris Vanities

Contemporary trough sinks give extra washing room.



Paris Basin (Polymarble)
P 500mm, 800mm, 1000mm, 1200mm

\$620



P50 500mm, 1 Drawer, Wall-hung, White / Melamine
W500 x H445 x D380

\$770



P80 800mm, 1 Drawer, Wall-hung, White / Melamine
W800 x H445 x D380

\$830



P100 1000mm, 1 Drawer, Wall-hung, White / Melamine, 1 or 2 Tapholes
W1000 x H445 x D380

\$1035



P120 1200mm, 2 Drawers, Side by side, Wall-hung, White / Melamine, 1 or 2 Tapholes
W1200 x H445 x D380

NEW



MCO
Charred Oak

MDF
Driftwood

MME
Manhattan Elm

MNA
Nordic Ash

MSO
Southern Oak

No Code
White

NB: Price includes a top, cabinet and handle (excludes tapware & accessories). *No soft-close drawers.

Small Space Vanities

NEW

FIT

Get practical and embrace minimalism with a side faucet.



FIT FIT40WHMSO

ICE

Clean-lined and confident with a minimalist design, the ceramic sink adds a touch of elegance to your space.

\$435

ICE45WH/ ICE45WHM
Ice 450mm, 1 Door, Wall-hung, Ceramic Basin, White / Melamine W450 x H400 x D275

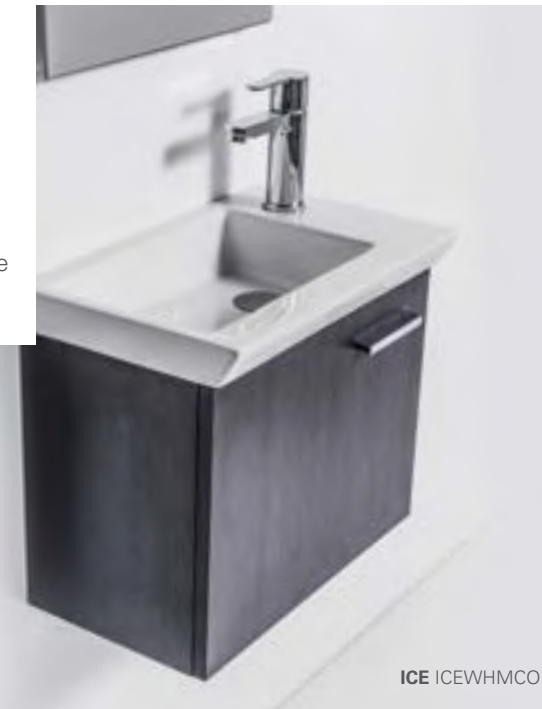

ICE ICE45WHMCO

NB: Price includes a top, cabinet and handle (excludes tapware & accessories). 'M' in product code indicates available in melamine finishes.

There are five finish options available. Paint (White Only): The paint used on our products is polyurethane or UV based. It is five times harder and more durable than lacquer finishes. **Timber Effect (Melamine):** Our wood grain melamine is a low-pressure laminate. **Five colours are available:** Charred Oak, Driftwood, Manhattan Elm, Nordic Ash & Southern Oak.



\$435

FIT40WH/ FIT40WHM
Fit 400mm, 1 Door, Wall-hung, Polymarble Basin, White / Melamine W400 x H420 x D200

\$475

FIT40/ FIT40M
Fit 400mm, 1 Door, Floor-standing, Polymarble Basin, White / Melamine W400 x H900 x D200



FIT FIT40WHMNA

\$480

SP500/ SP500M
Space 530mm, 1 Door, Floor-standing, China Basin, White / Melamine W530 x H900 x D250



SPACE SP500

SPACE

Maximising storage space in your bathroom.

\$450

SP500WH/ SP500WHM
Space 530mm, 1 Door, Wall-hung, China Basin, White / Melamine W530 x H420 x D250



FROM \$150

Z01 + Z01R
500mm, Space Basin (China) with Towel Rail, W530 x H60 x D250 **\$195**
Z01 Space Basin (China) Only **\$150**



Tall Cabinets



SLEEK, SLIM & SPACIOUS



\$680

TC06 3 open shelves, 2 drawers
White W300 x H1700 x D290



\$740

TC07 1 open shelf, 1 door, 2 drawers
White W300 x H1700 x D290



\$680

TC06M 3 open shelves, 2 drawers,
Melamine W300 x H1700 x D290



\$740

TC07M 1 open shelf, 1 door, 2 drawers,
Melamine W300 x H1700 x D290

There are five finish options available. Paint (White Only): The paint used on our products is polyurethane or UV based. It is five times harder and more durable than lacquer finishes. **Timber Effect (Melamine):** Our wood grain melamine is a low-pressure laminate. Five colours are available: Charred Oak, Driftwood, Manhattan Elm, Nordic Ash & Southern Oak.

Mirror Units

We all like to look our best – it's just sometimes we need a little help. And what better assistance than from one of our attractive mirror units. These stunning glass and stainless cabinets are made to last, so you can expect good luck and good looks.

STAINLESS STEEL MIRROR UNITS



\$215

SS01
2 Glass Shelves
W330 x H700 x D100



\$240

SS02
2 Glass Shelves
W430 x H700 x D100



M901M Mirror Unit 900mm

SERIES I

Without Pelmet & Lights.

Series 1 units on Page 30 are available in our superior white paint finish or a timber effect finish (melamine). Our wood grain melamine is a low-pressure laminate. Five colours are available: Charred Oak, Driftwood, Manhattan Elm, Nordic Ash and Southern Oak. 'M' in product code indicates available in melamine.

ADD LED LIGHT OR PELMET LIGHT

Pelmet Light on Page 31 is available in our superior white paint finish (with halogen light) or Melamine (with LED light). The paint used in our products is polyurethane or UV based. It is five times harder and more durable than lacquer finishes.



TC07M + SP90D2WHMDF Tall Cabinet with Splash
900mm 2 drawers vanity in Driftwood

Mirror Units

SERIES I

Without Pelmet & Lights

Our polyurethane is five times harder and more durable than lacquer finishes!

\$560

TC65 / TC65M
Without pelmet & lights, Corner Unit, 1 Door, 2 Shelves
W350 x H650 x D350



\$400

M301 / M301M
Without pelmet & lights, 300 Unit, 1 Door, 2 Shelves
W295 x H750 x D120



\$430

M601 / M601M
Without pelmet & lights, 600 Unit, 2 Doors, 2 Shelves
W587 x H750 x D120



\$495

M75 / M75M
Without pelmet & lights, 750 Unit, 2 Doors, 2 Shelves
W730 x H750 x D120



\$560

M901 / M901M
Without pelmet & lights, 900 Unit, 3 Doors, 6 Shelves
W880 x H750 x D120



\$545

M903 / M903M
Without pelmet & lights, 900 Unit, 2 Doors, 4 Shelves
W880 x H750 x D120



\$590

M105 / M105M
Without pelmet & lights, 1000 Unit, 2 Doors, 4 Shelves
W1030 x H750 x D120



\$610

M120 / M120M
Without pelmet & lights, 1200 Unit, 2 Doors, 4 Shelves
W1180 x H750 x D120



\$715

M1203 / M1203M
Without pelmet & lights, 1200 Unit, 3 Doors, 6 Shelves
W1180 x H750 x D120



LIGHTING OPTIONS

Add LED Light or Pelmet Light

FROM
\$135



2995.514 Lights IP44 rated
500mm Wide LED bathroom light
L500 x W100 x H30, 230V, 6W **\$135**
2995.814 Lights IP44 rated
800mm Wide LED bathroom light
L800 x W100 x H30, 230V, 10W **\$145**



FROM
\$145



PL600
M601(M) with pelmet & 1 light,
W580 x H775 x D120 **\$145**
PL750
M75(M) with pelmet & 2 lights,
W730 x H775 x D120 **\$185**
PL900
M901(M) or M903(M) with pelmet &
2 lights, W880 x H775 x D120 **\$185**
PL1050
M105(M) with pelmet & 2 lights,
W1030 x H775 x D120 **\$190**
PL1200
M120(M) or M1203(M) with pelmet &
2 lights, W1180 x H77 x D120 **\$195**



HEATED MIRROR PADS

Heated Mirror Pads are available on the M903, M105 and M120 units only.
Add \$100 for heat pads. Mirrors and mirror units have a one year guarantee if installed and maintained as per manufacturers instructions. NB: Pads are fitted to middle mirror and mirrors are screwed on.

PELMET LIGHT TECHNICAL

White pelmets thickness - 25mm
Melamine pelmets thickness - 16mm
NB: Pelmet price includes transformer and LED lights. (Lights IP44 rated)

Wash Basins

Unique and sophisticated, freeform basins add shape and a point of interest.



\$400

B1ACS
Form ClearStone Basin
W550 x H142 x D350



\$255

Z13
Onda 600
W590 x H150 x D400



\$210

Z12
Onda 500
W500 x H150 x D400

\$200

4A1.1161
Square Basin
W390 x H152 x D390



CERAMIC BASIN

Ceramic sinks are easy to clean and come in a range of great shapes.



\$185

4A1.1158
Round Basin
W392 x H152 x D392



\$245

4A1.1159
Oval Basin
W582 x H140 x D390



\$230

4A1.1160
Rectangle Basin
W550 x H155 x D380



AWASH WITH STYLE

New ClearStone basins.

B5ECS Sonit ClearStone Basin



\$390

B5ECS
Sonit ClearStone Basin
W550 x H142 x D350



\$410

B13ECS
Puro ClearStone Basin
W550 x H142 x D350

Tapware



\$250

PRO110DNC Basin Monobloc / Chrome
Single lever (Without pop-up waste),
Water flow regulator as standard,
Regulated to 5LPM (litres per minute),
Minimum pressure 0.5 Bar MP,
Plated brass
5 Star WELS Rating

\$225

158.G.21387 Single
Shower Mixer,
Single lever,
Suitable low or mains
pressure,
Wall-mounted,
Round face plate



\$190

5A3.1240
Single Lever Basin
Mixer
W45 x H164 x D138
5 Star WELS Rating



\$350

5A3.1378
Double Bath Filler
W55 x H166 x D197



MIKE PRO

Get smart with this
discreet lever mixer.



\$415

PRO120WNC
Basin 2 Hole set / Chrome
Wall-mounted (Without pop-up waste),
Water flow regulator as standard,
Regulated to 5LPM (litres per minute),
Spout projection 220mm,
Minimum pressure 0.5 Bar MP,
Plated brass
5 Star WELS Rating



\$430

5A3.1377
Mono Bath Filler
W55 x H166 x D197
5 Star WELS Rating

CRYSTAL

A classic tap to suit all
interiors. Engineered from
solid brass and double dipped
in chrome, giving them a
spectacular finish. Plus an
excellent WELS rating!



\$205

5A3.1375
Extended Single
Lever Basin Mixer
W45 x H324 x D138
5 Star WELS Rating



\$760

CW24
Mono Bath Filler
with Shroud
W55 x H166 x D197
5A3.1378 Shroud
W130 x H735 x D130



\$660

PROTHERM
Thermostatic Shower Valve
Double Shower Mixer
Single outlet thermostatic shower,
Twin lever & wall-mounted,
Precise thermostatic control, maintaining
selected temp to within +/- 1.5 °C,
Thermo ceramic disc cartridge,
Minimum pressure 0.2 Bar LP,
Suitable low or mains pressure



\$300

PRO111DNC
Basin Monobloc / Chrome
Single lever (Without pop-up waste),
Water flow regulator as standard,
Regulated to 5LPM (litres per minute),
Minimum pressure : 0.5 Bar MP,
Plated brass
5 Star WELS Rating



\$1500

PRO416FC
Bath Shower Mixer
Floor-Standing,
Bath shower mixer with kit,
Single lever,
Floor-mounted,
Spout projection 238mm,
Minimum pressure 3 Bar,
Plated brass



\$175

5A3.1379
Bath Shower Mixer
W132 x H192 x D77

\$210

5A3.1380
Bath Shower Mixer
with Diverter
W132 x H192 x D77

Shower Sets

COMBINED
SIMPLICITY



\$455

304.Q.16384 Class R Round Shower Set with Thermostatic Valve*
W265 x H1085 x D353 *2 Star WELS Rating*
NB: Minimum requirements 2 Bar balanced water pressure.

\$520

304.Q.16385 Class S Soft Square Shower Set with Thermostatic Valve*
W269 x H1085 x D353 *2 Star WELS Rating*
NB: Minimum requirements 2 Bar balanced water pressure.

\$140

203.M.11816 Foxy Shower Set
W121 x H682
2 Star WELS Rating (with restricter)
NB: Shower Elbow (6008026) is optional extra \$59.

*Thermostatic control - Set the temperature and maintain water temperature to within +/- 1.5 oC. Automatic safety shutdown should the hot or cold water supply fail with built-in safety control set at 38 oC with manual override for a safer shower. It's simple to install with wipe clean nozzle.

Baths



The Freestanding Bath

Well-loved by everyone. They are easy to install as they don't require framing from a builder, and they give a wonderfully spacious look.

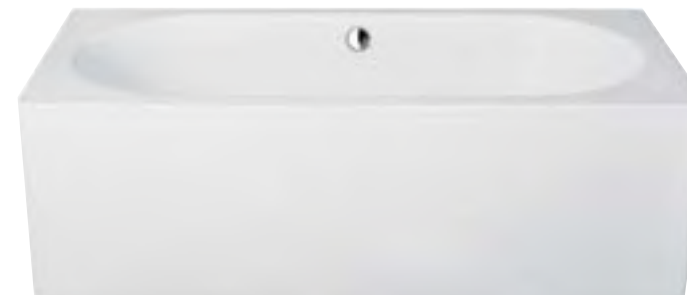

The Drop-In Tub

Fitted into a frame on-site using a platform.



The Whirlpool Tub

Gives you the added benefit of getting a massage while you relax and soak in the water. They have a range of controls to manipulate the strength of the water jets and the heat of the water. Anybody with a Whirlpool tub can enjoy a truly relaxing bathing experience!

PUT YOUR
FEET UP
AND RELAX

Which is the right bath for you?



The Shower Bath

A practical and space saving solution – perfect for a smaller bathroom!

ClearStone Baths

FORM CLEARSTONE

The internal space of this bath is bigger than most full-size regular baths, thanks to its narrow rim.

The baths are finished with high gloss surface in a brilliant white colour with exceptional performance, and is engineered to last a lifetime. By using the best material, ClearStone baths are thinner with more delicate edge outlines.



\$3099

N3BCS Patinato Clearstone
W1690 x H550 x D800
Product Weight: 91kg
Displaced Capacity: 204 litres
(bath's capacity less 70 litres)
ClearStone material: Sedimentary stone composite with Gibbsite mineral filler
NB: Price includes waste.

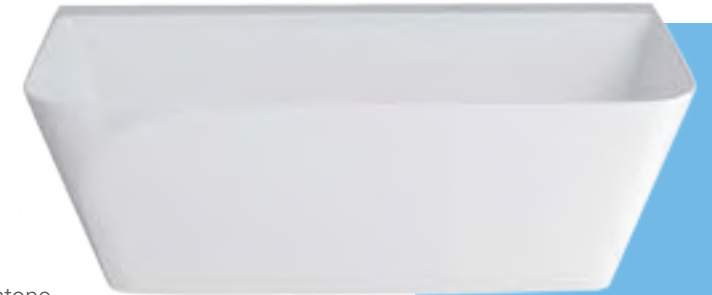

PATINATO CLEARSTONE

Classic back to wall bath in geometric angles with slim, sharp edges.

\$2699

N3ACS Patinato Petite Clearstone
W1524 x H550 x D800
Product Weight: 85kg
Displaced Capacity: 167 litres
(bath's capacity less 70 litres)
ClearStone material: Sedimentary stone composite with Gibbsite mineral filler
NB: Price includes waste.



\$2899

325.A.21128 Form ClearStone
W1690 x H570 x D800
Product Weight: 84kg
Displaced Capacity: 272 litres
(bath's capacity less 70 litres)
ClearStone material: Sedimentary stone composite with Gibbsite mineral filler
NB: Price includes waste.



\$2499

325.A.21127 Form Piccolo ClearStone
W1500 x H570 x D800
Product Weight: 67kg
Displaced Capacity: 218 litres
(bath's capacity less 70 litres)
ClearStone material: Sedimentary stone composite with Gibbsite mineral filler
NB: Price includes waste.



SONIT CLEARSTONE

A luxurious curvaceous bath with generous sloped sides.

\$2499

N8ECS Sonit ClearStone
W1690 x H580 x D700
Product Weight: 71kg
Displaced Capacity: 179 litres
(bath's capacity less 70 litres)
ClearStone material: Sedimentary stone composite with Gibbsite mineral filler
NB: Price includes waste.



Natural Stone Baths



FORM

Manufactured using our natural stone & mineral technology, these baths are one piece. Designed so that they don't weigh a tonne.



\$2835

1B1.1311 Form
W1690 x H555 x D800
Product Weight: 102kg
Bath Water Volume: 362 litres*/292 litres**
NB: Price includes waste.



\$2245

N1A Form Piccolo
W1500 x H555 x D750
Product Weight: 92kg
Bath Water Volume: 230 litres*/160 litres**
NB: Price includes waste.

Acrylic Baths



NEW

\$1695

15.B.26725
Lucite
W1700 x H600 x D800
NB: Price includes pop-up waste.



NEW

\$1640

15.B.26772
Lucite Mini
W1500 x H610 x D800
NB: Price includes pop-up waste.

THE LATEST SOAKERS

The design feature a back to wall ledge to sit flush against a wall, maximising space in your bathroom!



SONIT

A bath typically weighs around 110kg and is 1cm thick throughout the entire surface. The finish is smooth, solid and velvety to touch. Natural stone is without question the best the market has to offer.



\$2420

1B1.1310 Sonit
W1690 x H580 x D700
Product Weight: 90kg
Bath Water Volume: 274 litres*/204 litres**

NB: Price includes waste.

* Volume of water contained in the bath if filled to the overflow.

** Volume of water contained in the bath if filled to the overflow less 70 litres to allow for an average person in the bath.

\$1795

319.B.19907
Immerge
W1700 x H580 x D750
NB: Price includes pop-up waste.



FROM \$1430

RLG-1500
Mini Tasman
Lucite® Acrylic*
Bath & Panel
W1500 x H630 x D800 **\$1430**

RLG1803 Tasman
Lucite® Acrylic*
Bath & Panel
W1800 x H630 x D800 **\$1455**

NB: Prices includes pop-up waste.

*Lucite® Acrylic – a sensual surface with excellent thermal properties. It retains heat and is warm to touch.



IMMERSE YOURSELF IN LUXURY

\$1350

1B1.1430
Saturn
W1700 x H630 x D750
NB: Price includes pop-up waste.



\$1720

319.B.19909
Loop
W1695 x H595 x D820
NB: Price includes pop-up waste.



Skirt Baths

**DRESS
A BATH
TO YOUR
TASTE**



ADD BATH SCREEN

QP99 Bath Screen
(Square Pivot Panel)
High lustre aluminium
Adjustment :
1175 - 1195mm
W1175 x H1500 **\$455**
NB: Handle included.
Install all screens on
flat edge baths only.



FROM
\$570

1B1.1140 Drop Me 1700 Rectangle Bath
W1700 x H430 x D750 **\$570**
1B1.1141 Drop Me 1800 Rectangle Bath
W1800 x H430 x D800 **\$690**



FROM
\$570

1B1.1148 Drop You 1700 Rectangle Bath
W1700 x H430 x D750 **\$570**
1B1.1149 Drop You 1800 Rectangle Bath
W1800 x H430 x D800 **\$645**
NB: Prices include pop-up waste.
Height of bath does not allow for feet or panels.
Height of feet adjustable from 110 - 150mm.



▲ 4-SIDED SKIRT

SIDED SKIRT

1B1.1142 1700 4-Sided Skirt
W1700 x H590 x D40 **\$725**
1B1.1143 1800 4-Sided Skirt
W1800 x H590 x D40 **\$740**
NB: Prices are for panels/skirt only
and do not include the price of bath.



▲ END PANEL

BATH PANEL

1B1.1150 1700 Bath Front Panel
W1700 x H535 x D40 **\$255**
1B1.1151 1700 Bath End Panel
W732 x H535 x D40 **\$165**
1B1.1152 1800 Bath Front Panel
W1800 x H535 x D40 **\$255**
1B1.1153 1800 Bath End Panel
W782 x H535 x D40 **\$165**

◀ FRONT PANEL

Drop-In Bath Features:

- Built stronger to withstand 2.3 tonnes.
- Retains heat for 30 minutes longer than a standard bath.
- Supplied with galvanised steel leg frame.
- Manufactured from 30% recycled material.
- 100mm diameter steel reinforcing rod runs inside rectangular bath rims.



\$514

198.A.19175
Square Drop-In
W1700 x H450
x D750
NB: Price includes
pop-up waste.

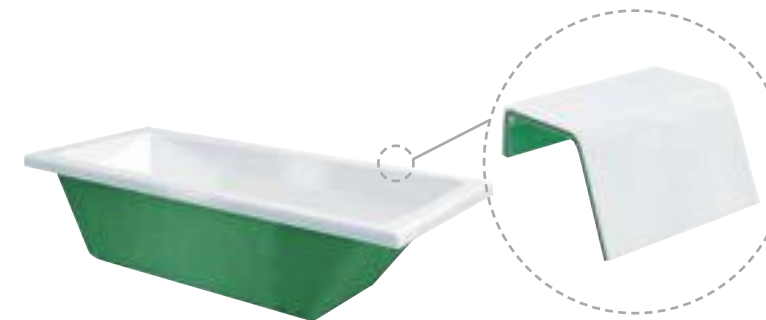

▲ Steel reinforcing rod bath rims

**ECO
FRIENDLY
DROP-IN
BATH**

Looking for a
greener bath?
Look no further.



Whirlpool Baths



FROM
\$1995

1B1.1146 1700 Whirlpool Bath W1700 x H430 x D750 **\$1995**
1B1.1147 1800 Whirlpool Bath W1800 x H430 x D750 **\$2045**
NB: Whirlpool baths should be installed by a fully qualified electrician.
We take no responsibility for the fitting or installation of electrical items.

A whirlpool bath gives you the ultimate therapeutic spa experience, in your own home! Ease the stresses of the day while you sink back and indulge yourself in a pulsating massage that can be tailored to suit your individual needs!

Shower Baths

B SHOWER BATH

Perfectly proportioned space savers.



Both B Shower and Square Shower baths are made from Lucite® Acrylic - a sensual surface with excellent thermal properties. It retains the heat and is warm to touch.

\$615

1B1.1013 B Shower Bath - *Left*
W1700 x H400 x D805

1B1.1014 B Shower Bath - *Right*
W1700 x H400 x D805

BATH PANEL

1B1.1023 B Shower Bath Front Panel W1700 x H535 x D40 **\$295**

1B1.1024 B Shower Bath End Panel W720 x H535 x D40 **\$190**

Long side acrylic upstands (over 1200mm) **\$120**

Short side acrylic upstands (less than 1200mm) **\$95**

GLASS SCREEN

2A1.1207 B Shower Bath Screen
W900 x H1450 **\$340**

NB: Install all screens on flat edge baths only.

3M GLASS PROTECTION SYSTEM INCLUDED!

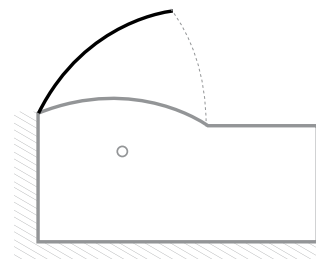

2A1.1207 Screen Opening



SQUARE SHOWER BATH

A splash of elegance.

\$775

1B1.1011 Square Shower Bath - *Left*
W1700 x H425 x D850

1B1.1012 Square Shower Bath - *Right*
W1700 x H425 x D850

BATH PANEL

1B1.1144 Square Shower Bath Front Panel W1700 x H535 x D40 **\$320**

1B1.1145 Square Shower Bath End Panel W720 x H535 x D40 **\$180**

Long side acrylic upstands (over 1200mm) **\$120**

Short side acrylic upstands (less than 1200mm) **\$95**

GLASS SCREEN

BS9/L Eco Bath Screen - *Left*. Aluminium alloy profile with safety glass. Screen opens both inwards and outwards. W820 x H1450 **\$499**

BS9/R Eco Bath Screen - *Right*. Aluminium alloy profile with safety glass. Screen opens both inwards and outwards. W820 x H1450 **\$499**

2A1.1206 Square Shower Bath Screen
W850 x H1550 **\$490**

NB: Install all screens on flat edge baths only.

Matching shower screens to ergonomic shapes of our shower baths, creates a relaxing and natural bathing experience – even in the smallest bathroom!

3M GLASS PROTECTION SYSTEM INCLUDED!

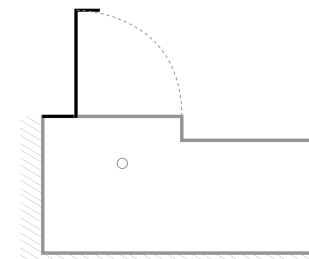

BS9/L Screen Opening

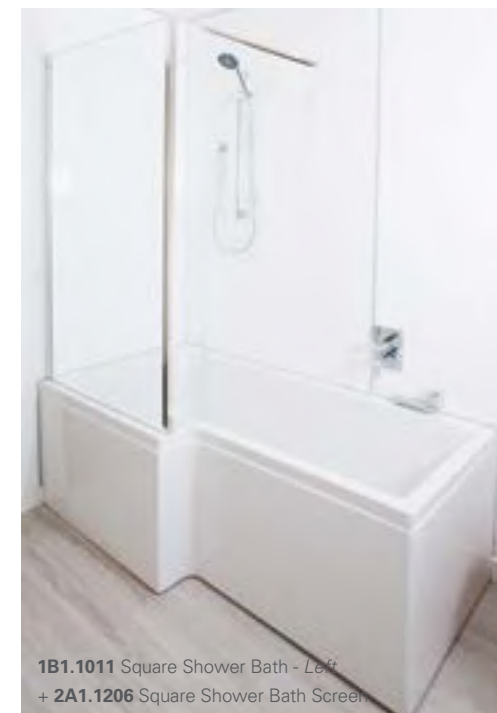

1B1.1011 Square Shower Bath - *Left*
+ 2A1.1206 Square Shower Bath Screen



1B1.1011 Square Shower Bath - *Left*
+ BS9/L Eco Bath Screen - *Left*

Non-Stock Baths

CLEARSTONE BATHS

Duo ClearStone
W1550 x H490
x D950



Balthazar Clearstone
W1675 x H711
x D761



Florence ClearStone
W1524 x H570
x D750



Palermo Petite ClearStone
W1524 x H570
x D750

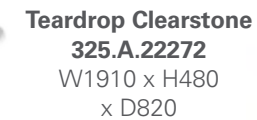

Teardrop Clearstone
325.A.22272
W1910 x H480
x D820



Teardrop Petite Clearstone
325.A.22271
W1690 x H480 x
D820

NATURAL STONE BATHS

Finding the right bath for your bathroom isn't always easy. At VCBC, we wanted to make it easier for you to find the right one!



Lonio
W1700 x H665
x D750



Nebbia N14
W1600 x H800
x D800



Palermo 1B1.1410
W1800 x H555
x D750



Palermo Piccolo 1B1.1411
W1600 x H555
x D750



Vista 1B1.1412
W1790 x H555
x D750

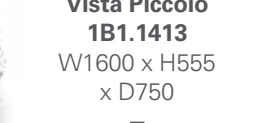

Vista Piccolo 1B1.1413
W1600 x H555
x D750

Showers

SHOWERING SOLUTIONS

EASY TO INSTALL

Our shower enclosures have been designed so they're really simple for your plumber to install, helping save you money.

SAFETY IN MIND

Safety is critically important to us and all our enclosures are manufactured to New Zealand safety standards. Safety is never compromised in our stylish designs.

PROTECTION PLUS

VCBC showers have rise and fall hinges, protecting the rubber seals and improving water tightness. All screens have 3M glass protection included.

BUILT TO LAST A LIFETIME

We carry out rigorous testing on our doors, so you know a VCBC shower will stand the test of time.

TEMPERED GLASS

All VCBC shower enclosures are fitted with 6mm or 8mm toughened glass.

SLIMMER TRAYS

Our range of lightweight acrylic trays are designed to add a sturdy base to our great range of enclosures.

POLISHED ALUMINIUM FRAMES

We use high-quality aluminium frames in all our enclosures which ensure strength and rigidity over years of use.

WALL LINERS & UPSTAND OPTIONS

Patented sealing tape or acrylic upstand (page 59).

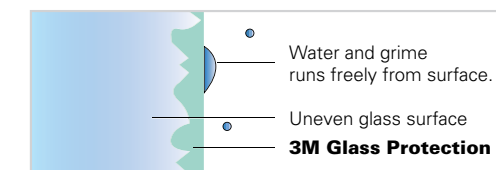
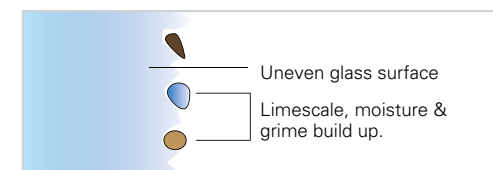
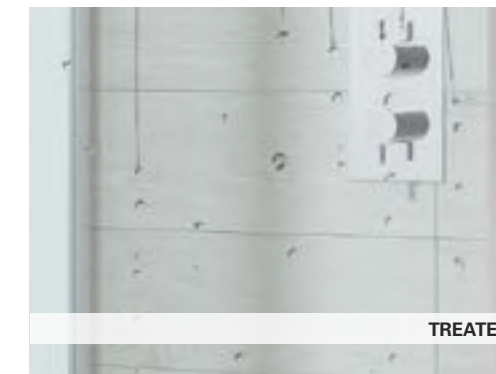

With 3M Glass Protection, you can keep stains and water spots at bay, and ensure your shower glass sparkles just the way it did when you first laid eyes on it.

THE ULTIMATE 3M GLASS PROTECTION

Your brand-new shower deserves to always look its best.

Lucca Quadrant Sliding Shower

SLIDING DOOR

Smooth single door operation.

6mm toughened glass sliding door; power showerproof, reversible, 15mm adjustment per panel for easier installation.

3M GLASS PROTECTION SYSTEM INCLUDED!

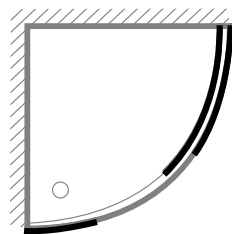

Door Opening

LUCCA QUADRANT TECHNICAL

Height excluding shower tray.
Reversible door design. 6mm safety glass.
3M ultimate glass protection.

PACKAGE PRICE INCLUDES

Includes shower door with return, 2-sided acrylic wall liner, shower tray with upstands, waste and glue pack.



EQ900 900mm Sliding Single Door

\$810

EQ900 900mm Single Door H1950
Door Entry: 480mm
Adjustment: 870-885mm

NB: Shower door only.

\$870

EQ1000 1000mm Single Door H1950
Door Entry: 480mm
Adjustment: 970-985mm

NB: Shower door only.

PACKAGE FROM \$1500

LC90Q 900mm Package **\$1500**
LC100Q 1000mm Package **\$1650**

Lucca Infold Shower

INFOLD DOOR

Distinctively sleek with clean lines.

Power showerproof, reversible design with silver finish frame. 30mm adjustment for easy fitting per panel. Doors can be fitted by themselves for alcoves or with side panels.

3M GLASS PROTECTION SYSTEM INCLUDED!

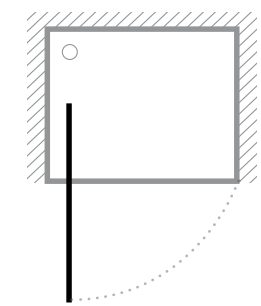

Door Opening

LUCCA INFOLD TECHNICAL

Height excluding shower tray.
Reversible door design. 6mm safety glass.
3M ultimate glass protection.

PACKAGE PRICE INCLUDES

Shower door & return, 2-sided acrylic wall liner, shower tray with 2 upstands, easy clean waste and glue pack.



16.D.13300 900mm Single Infold Door

\$660

16.D.13300 900mm Single Infold Door.
H1950
Door Entry: 695mm
Adjustment: 860-890mm

NB: Shower door only.

\$685

16.D.13301 1000mm Single Infold Door.
H1950
Door Entry: 695mm
Adjustment: 960-990mm

NB: Shower door only.

PACKAGE FROM \$1700

LI90 900mm Package **\$1700**
LI100 1000mm Package **\$1800**

SIDE SCREEN FROM \$375

2A1.1456 900mm Side screen H1950
\$375 Adjustment: 875-890mm
2A1.1457 1000mm Side screen H1950
\$400 Adjustment: 975-990mm

Lucca Alcove Shower

**SWING DOOR
IN RECESS**

Easy to install
with minimal fuss
and tools.

This innovative and contemporary range has been designed with a reversible door design for added convenience. Perfect when fitting into alcoves.

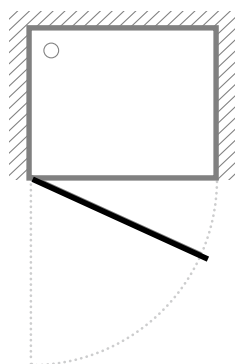

Door Opening

LUCCA ALCOVE TECHNICAL

Height excluding shower tray.
Reversible door design. 6mm safety glass.
3M ultimate glass protection.

**3M GLASS PROTECTION
SYSTEM INCLUDED!**



16.D.20943 900mm Lucca Swing Door

\$575

16.D.20943
900mm Lucca Swing Door
H1950 Door Entry: 672mm
Adjustment: 870-890mm
NB: Shower door only.

Lucca Showers

The Lucca range
features a fantastic
frameless glass
system.

**FLAWLESS,
FRAMELESS
GLASS**

\$685

16.D.13045
Lucca 760 x 900mm
(760 door, 900 panel)
Door & Panel
(Rectangle) H 1950
High lustre aluminium
Adjustment: 725-750
x 865-890

**PACKAGE
LC7690**
760 x 900mm
Package
\$1365

\$685

16.D.13044
Lucca 900 x 760mm
(900 door, 760 panel)
Door & Panel
(Rectangle) H 1950
High lustre aluminium
Adjustment: 865-890
x 725-750

**PACKAGE
LC9076**
900 x 760mm
Package
\$1365

\$700

16.D.12144
Lucca 900 x 900mm
Door & Panel
(Square) H 1950
High lustre aluminium
Adjustment: 865-890

**PACKAGE
LC90**
900 x 900mm
Package
\$1395

\$740

16.D.13043
Lucca 1000x1000 mm
Door & Panel
(Square) H 1950
High lustre aluminium
Adjustment: 965-990

**PACKAGE
LC100**
1000 x 1000mm
Package
\$1475

**3M GLASS PROTECTION
SYSTEM INCLUDED!**

LUCCA TECHNICAL

Height: All showers are 1850 or 1950mm
(excluding shower tray). 6mm safety glass.
3M ultimate glass protection.

PACKAGE PRICE INCLUDES

Shower door & return, 2-sided acrylic wall
liner, shower tray with 2 upstands, easy clean
waste and glue pack.



16.D.13044 900 x 760mm Lucca Door & Panel

Assisi Showers

WIDE OPEN SPACES INDOORS

This stylish range gives a feeling of openness and space ensuring you enjoy the most luxurious walk-in shower experience.

The range is available in three sizes, all of which can be configured to open on both sides or one side only and with option of glass returns. They can be fixed back to the wall or vertically to the ceiling, whichever suits your needs best.

\$965

ASSISI SHOWER PACKAGE

Assisi 1000mm Panel Package (Package includes BOX 1, BOX 5, BOX 6 & BP1G-A)
NB: Price does not include tray or fixtures.

FRONT SCREEN

- BOX 1** 1000mm Walk-in. Front Screen **\$385**
- BOX 2** 1200mm Walk-in. Front Screen **\$445**
- BOX 3** 1400mm Walk-in. Front Screen **\$505**

RETURN GLASS PANEL

BOX 4 330mm Walk-in Side Screen
To be fitted to glass front panel **\$245**

SIDE SCREEN

BP1G-A 577mm Side Screen & Profile **\$325**

FITTINGS

- BOX 5** Walk-in Wall Profile Set **\$120**
- BOX 6** Walk-in Wall Support Bar **\$120**
- BOX 7** Walk-in Ceiling Support **\$185**



Assisi 1000mm Panel Package

ASSISI TECHNICAL

A range of open showers available in three sizes: 1000mm, 1200mm and 1400mm. Height: All showers are 2000mm (excluding shower tray) 8mm safety glass. 3M ultimate glass protection.

NB: All fittings are finished in High lustre aluminium. Please refer to page 56 & 57 for Assisi combination options. Liners not available for Assisi range. These showers are best suited to wet room installation. Please check with installers/local regulations for suitability.

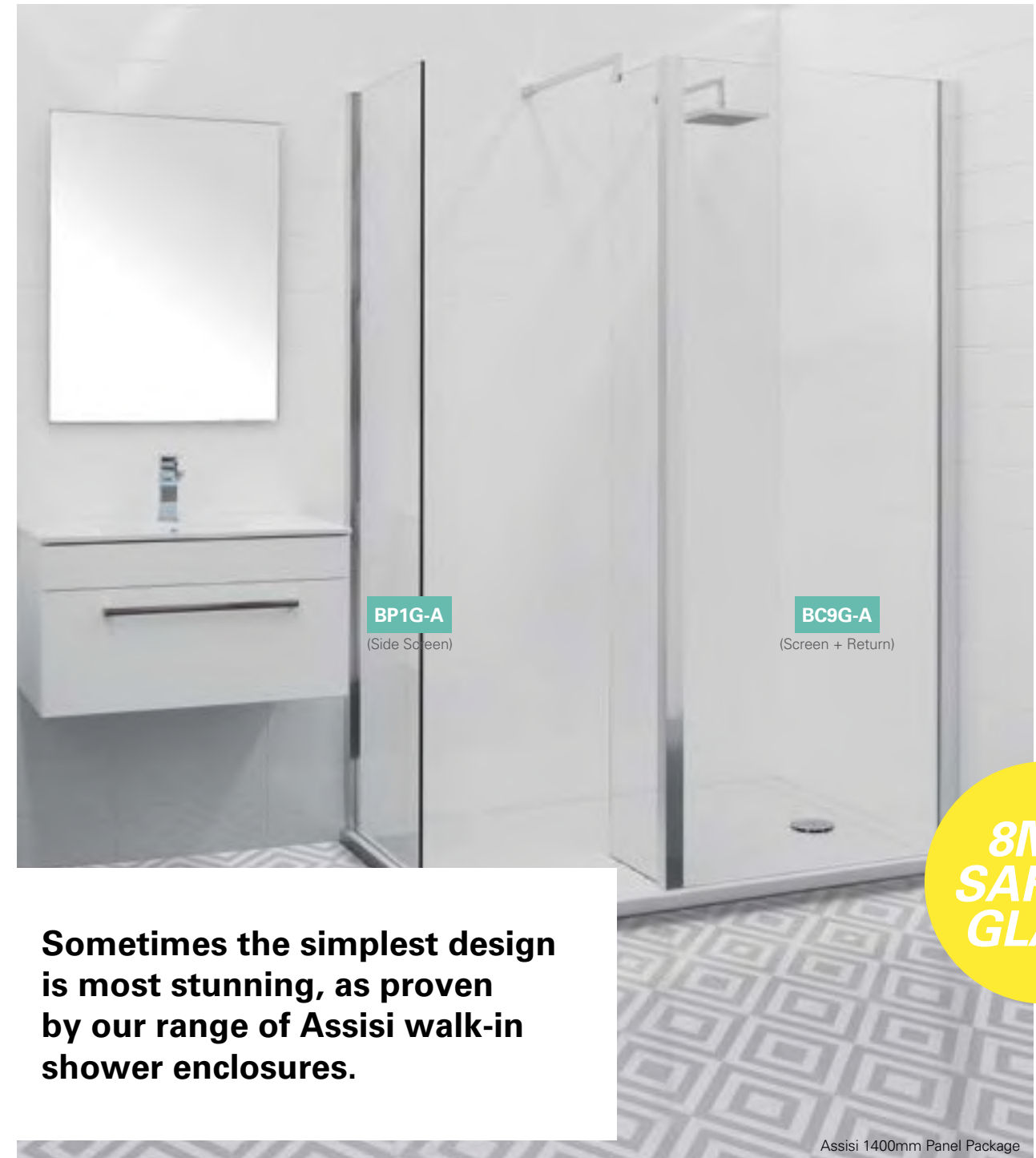

Assisi 1400mm Panel Package

Sometimes the simplest design is most stunning, as proven by our range of Assisi walk-in shower enclosures.

With a wide range of door sizes and side panels, you can choose the combination to suit your space.

3M GLASS PROTECTION SYSTEM INCLUDED!

8MM SAFETY GLASS

\$965

ASSISI SHOWER PACKAGE

Assisi 1400mm Panel Package

BC9G-A & BP1G-A

Package includes front screen with return panel, side screen and profiles.

NB: Price does not include tray or fixtures. Shower tray: BSF-1490 **\$730**

Central Showers

**ROLLS BY
AND ALWAYS
MAKES AN
IMPRESSION**

**8MM
SAFETY
GLASS**



16.D.17329 1600mm Central Slider Single Door

FROM \$1975

CENTRAL SHOWER PACKAGE

CT1290 1200 x 900 Package **\$1975**

CT1490 1400 x 900 Package **\$2170**

CT1690 1600 x 900 Package **\$2395**

CENTRAL TECHNICAL

8mm toughened clear glass, 3M ultimate glass protection. 20-30mm adjustment for easy fitting.

PACKAGE PRICE INCLUDES

All package includes slider door, panel, tray with upstands, waste, 2-sided liner and glue packs.

Doors can be fitted by themselves or with a side panel. A reversible design for a left- or right-hand shower. A unique polished chrome finish that coordinates with all tapware to complete the luxury look.

3M GLASS PROTECTION SYSTEM INCLUDED!

FROM \$795

SINGLE SLIDER DOOR

16.D.11488 1200mm Central slider, single door, W1160 x H1950 **\$795**

16.D.11489 1400mm Central slider, single door, W1360 x H1950 **\$855**

16.D.17329 1600mm Central slider, single door, W1560 x H1950 **\$995**

16.D.12140 1700mm Central slider, single door, W1660 x H1950 **\$1040**

DOUBLE SLIDER DOOR (ALCOVE ONLY)

16.D.11480 1200mm Central slider, double door, W1160 x H1950 **\$1095**

SIDE SCREEN

16.D.11490 800mm Central side panel W775 x H1950 **\$398**

16.D.11491 900mm Central side panel W875 x H1950 **\$425**

16.D.12143 1000mm Central side panel W975 x H1950 **\$445**



16.D.11488 1200mm Central Slider Single Door
+ **16.D.11491** 900mm Central side panel

Acrylic Shower Trays

SHOWER TRAY PRICE INCLUDES

Tray, sealing tape, easy clean waste and acrylic upstands on two sides.

\$475

BSF-9076S
Rectangle Shower Tray
W900 x H35 x D760



\$495

BSF-9090R
Quadrant Shower Tray
W900 x H35 x D900
NB: Only available as a right-hand curve



\$775

BSF-1780
Walk-in Shower Tray
W1700 x H35 x D800



FROM \$780

1B2-1342 Rectangle Shower Tray
W1700 x H35 x D900 **\$780**
1B2-1309 W1800 x H35 x D900 **\$810**



FROM \$810

1B2-1343 Rectangle Shower Tray
W1700 x H35 x D1000 **\$810**
1B2-1345 W1800 x H35 x D1000 **\$840**



\$595

BSF-1000R
Quadrant Shower Tray
W1000 x H35 x D1000
NB: Only available as a right-hand curve



\$615

BSF-1290R / BSF-1290L
Quadrant Shower Tray
W1200 x H35 x D900
NB: Available as a right or left-hand curve



\$565

Z1175
Rectangle Shower Tray
W1200 x H35 x D800



NEW

\$595

BSF-1290S
Rectangle Shower Tray
W1200 x H35 x D900



\$635

1B2.1305
Rectangle Shower Tray
W1200 x H35 x D1000



\$710

BSF-1490C
Rectangle Shower Tray
W1400 x H35 x D900

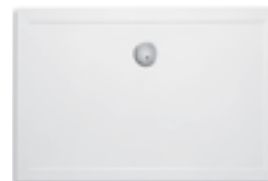

\$420

Z1409
2-Sided Moulded Upstands Shower Tray
W910 x H55 x D910



\$460

Z1411
2-Sided Moulded Upstands Shower Tray
W1010 x H55 x D1010



\$730

BSF-1490
Walk-in Shower Tray
W1400 x H35 x D900



\$750

BSF-1600
Walk-in Shower Tray
W1600 x H35 x D800



\$755

1B2.1304
Rectangle Shower Tray
W1600 x H35 x D900



\$420

Z1410
3-Sided Moulded Upstands Shower Tray
W910 x H55 x D910



\$460

Z1412
3-Sided Moulded Upstands Shower Tray
W1010 x H55 x D1010



Our fashionably slender shower trays are so subtle that you can apply them to any bathroom scheme. Designed to suit a range of shower configurations and enclosures, these superior slimline trays are built to last with impeccable strength.

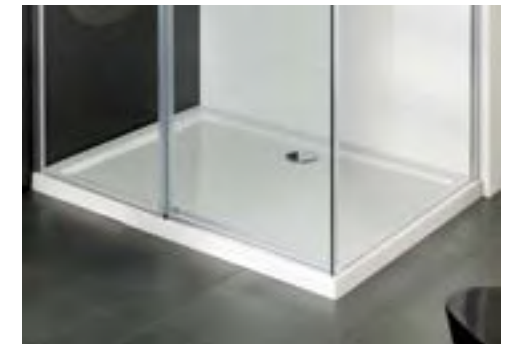

THE SLIMMER THE BETTER

Acrylic Shower Trays

ABOUT OUR SHOWER TRAYS

All you need to get your shower looking modern, stylish and elegant.

Our range of lightweight acrylic shower trays have been designed with the best quality materials and a contemporary look. All trays come with an easy clean waste and sealing tape and acrylic upstands on two sides.

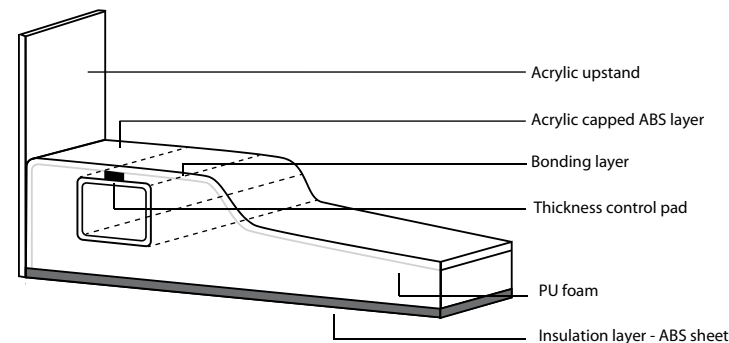

PU TRAYS

The trays are acrylic capped reinforced trays with a smooth under-surface. (Available with upstands, refer to page 59)

Recommended Installation Of Shower Trays With Moulded Upstands

Factory fitted upstand detail



Installation of an acrylic shower tray with tiles

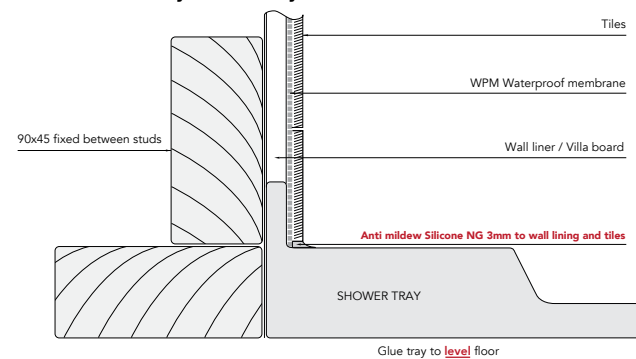

VCBC shower installation with acrylic liner

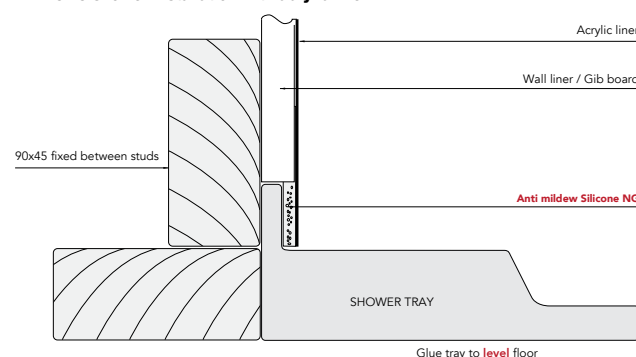

Shower Components



\$40

HFW
Easy Clean Waste



\$53 ▲

SF586
Tiling Strip -
3000mm length

YOUR CHOICE OF FINISHING TOUCHES



\$45

2WGP
2 Wall Glue Pack
for Acrylic Wall
Shower. 2 glue,
1 clear sealant

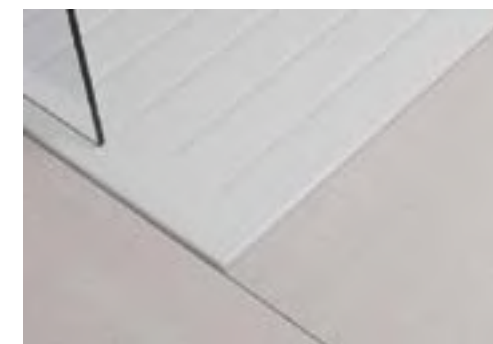

▲ Recessed Shower & Tray



▲ Factory fitted upstand detail

FROM \$95

LONG SIDE UPSTAND
1200mm & over **\$120**
SHORT SIDE UPSTAND
Less than 1200mm **\$95**

FROM \$290 ▲

LINERS

2-Sided Acrylic Wall Liners \$290
1850 or 1950 high to suit up to:
760 x 900, 900 x 900, 1000 x 1000
& 1200 x 900

3-Sided Acrylic Wall Liners \$490
Fit 900 x 900mm and 1000 x 1000mm
moulded trays only
LNR9090901950
Measurements: 885 x 875 x 885 x 1950
LNR1010101950
Measurements: 985 x 975 x 985 x 1950

Accessories

\$105

FT42038 Star Bottle Trap
32mm, chrome plated.



\$67

40551-32 Bottle Trap 1 1/4" All brass,
chrome plated.



**FINISHING
DETAILS ARE
IMPORTANT
TOO**

\$15

6051 Angle s tap with filter. All brass, chrome
plated. NB: Can be fitted with flexi hose.



\$40

PUW68R Pop up waste - 65mm round.



\$30

FT41045 Waste with flip plug.



\$15

A27 Basin waste and white plug.



\$30

WSB7655 Basket waste for Laundry Tub.



\$75

15.M.18171
S Pan Converter - Straight connector.
NB: Two separate boxes.



\$50

STC Connector for back to wall pans
150-210mm.



Onda Toilets

\$775

OZ266
Onda close coupled
toilet suite with one
piece cistern and soft
close seat
4 Star WELS Rating



\$390

OZ14
Onda back to wall
pan with soft
close seat



**SUSTAINABLE
DUAL FLUSH
OPTION**

Onda is a classic shaped
range and features soft close seat
and dual flush.

\$380

OZ15-PS
Onda wall hung pan
with soft close seat



\$635

OZ306
Onda close coupled
toilet suite with
cistern, lid and soft-
close seat
4 Star WELS Rating



\$360

Z22
Onda back
to wall bidet



ONDA PACKAGES

BACK TO WALL PACKAGE

Onda back to wall pan, in-wall cistern,
face plate & soft close seat

OZ14-C With white plate **\$599**

OZ14-CP With chrome gloss plate **\$616**

OZ14-CM With chrome matt plate **\$616**

WALL-HUNG PACKAGE

Onda wall hung pan, steel frame in-wall
cistern, face plate & soft close seat

OZ15-C With white plate **\$730**

OZ15-CP With chrome plate **\$755**

OZ15-CM With chrome matt plate **\$755**

NB: Please specify which face plate when ordering.
See page 64 for in-wall cisterns and face plate options.

Vitreous china suites with glazed box rim and trap. Efficient 4.5/3 litre flush distribution. Removable soft close seat with stainless steel hinges.

Fine Angled Toilets



\$660

S40-6880
Fine toilet suite with two-piece cistern and angled soft-close seat and lid
4 Star WELS Rating



\$395

S40-7127
Fine back to wall pan with angled soft-close seat



S40-6880 Fine Toilet with angled soft-close seat and lid

LOOKING SHARP IN THE LITTLEST ROOM

Fine Round Toilets



\$380

S40-6926
Fine wall hung toilet with round soft-close seat



\$650

S40-6836
Fine toilet suite with two-piece cistern and angled round soft-close seat and lid
4 Star WELS Rating

\$390

S40-7126
Fine back to wall pan with round soft-close seat



\$790

S40-6834
Fine toilet suite with one-piece cistern and round soft-close seat and lid
4 Star WELS Rating

ALL-ROUND QUALITY WHERE IT COUNTS



\$790

S40-6881
Fine toilet suite with one-piece cistern and angled soft-close seat and lid
4 Star WELS Rating



\$390

S40-6927
Fine wall hung toilet with angled soft-close seat

FINE ANGLED PACKAGES

BACK TO WALL PACKAGE

Fine angled back to wall pan, in-wall cistern, face plate & soft close seat

- S40.7127-CW** With white plate **\$599**
- S40.7127-CP** With chrome plate **\$616**
- S40.7127-MP** With chrome matt plate **\$616**

WALL-HUNG PACKAGE

Fine angled wall-hung pan, steel frame in-wall cistern, face plate and soft-close seat

- S40.6927-CW** With white plate **\$730**
- S40.6927-CP** With chrome plate **\$755**
- S40.6927-MP** With chrome matt plate **\$755**

NB: Please specify which face plate when ordering. See page 64 for in-wall cisterns and face plate options.



\$365

S40-1972
Fine back to wall bidet



FINE ROUND PACKAGES

BACK TO WALL PACKAGE

Fine round back to wall pan, in-wall cistern, face plate & soft close seat

- S40.7126-CW** With white plate **\$599**
- S40.7126-CP** With chrome plate **\$616**
- S40.7126-MP** With chrome matt plate **\$616**

WALL-HUNG PACKAGE

Fine round wall-hung pan, steel frame in-wall cistern, face plate and soft-close seat

- S40.6926-CW** With white plate **\$730**
- S40.6926-CP** With chrome plate **\$755**
- S40.6926-MP** With chrome matt plate **\$755**

NB: Please specify which face plate when ordering. See page 64 for in-wall cisterns and face plate options.

In-wall Cisterns

STYLISHLY DISCREET

In-wall cisterns & flush plates.
Out of sight, out of mind.

\$410 ▶

3D1.1004

In-wall cistern with steel frame. Adjustable dual flush valve and height frame.

4 Star WELS Rating



\$230 ▶

3D1.1005

In-wall cistern. Adjustable dual flush valve.

4 Star WELS Rating



**K5130
FLUSH PLATE -
ROUND**



\$66

3D1.1006
White



\$82

3D1.1007
Chrome High Gloss



\$82

3D1.1008
Chrome Matt



\$82

K5130-23
Black

**K5131
FLUSH PLATE -
RECTANGLE**



\$66

3D1.1009
White



\$82

3D1.1010
Chrome High Gloss



\$82

3D1.1011
Chrome Matt



\$82

K5131-23
Black

Fabulous in-wall cisterns fit into 90mm walls.
The fully framed cistern has adjustable height
and comes complete with 100mm water outlet.

WALL-HUNG VANITIES

Product Code	Width	Height*	Depth	Doors/Drawers	Configuration	Fresh (FR)	Zara (Z)
60DWH	600	450	442	1 drawer	-		
60D2WH	600	450	442	2 drawer	Top & bottom		
75WH	750	450	442	2 door	-		
75DWH	750	450	442	1 drawer	-		
75D2WH	750	450	442	2 drawer	Top & bottom		
75D2WHX	750	650	467	2 drawer	Top & bottom		
90WH	900	450	442	2 door/1 drawer	-		
90DWH	900	450	442	1 drawer	-		
90D2WH	900	450	442	2 drawer	Top & bottom		
90D2WHX	900	650	467	2 drawer	Top & bottom		
100WH	1000	450	442	2 door 1 drawer	-		
100DWH	1000	450	442	1 drawer	-		
100D2WH	1000	450	442	2 drawer	Top & bottom		
120WH	1200	450	442	2 door 2 drawer	-		
120DWH	1200	450	442	1 drawer	-		
120D2WH	1200	450	442	2 drawer	Side by side/Single Bowl		
120D2WHX	1200	650	442	2 drawer	Top & bottom		
120D2WHSB	1200	450	442	2 drawer	Top & bottom		
150D2WH	1500	450	442	2 drawer	Side by side/Single & Double Bowl		

FLOOR-STANDING VANITIES

Product Code	Width	Height*	Depth	Doors/Drawers	Configuration	Fresh (FR)	Zara (Z)
60	600	800	442	2 drawer	-		
75	750	800	442	1 door 2 drawer	-		
75D2FL	750	800	442	2 drawer	-		
90	900	800	442	2 door 2 drawer	-		
90D2FL	900	800	442	2 drawer	-		
100	1000	800	442	2 door 2 drawer	-		
100D2FL	1000	800	442	2 drawer	-		
120	1200	800	442	2 door 4 drawer	-		
120D2FL	1200	800	442	2 drawer	-		
120D2FL	1200	800	442	2 drawer	Double Bowl		
1504DFL	1500	800	442	4 drawer	Double Bowl		

SPLASH VANITIES

Product Code	Width	Height*	Depth	Doors/Drawers	Configuration
SP60DWH	600	325	442	1 drawer	-
SP60D2WH	600	450	442	2 drawer	Top & bottom
SP90DWH	900	325	442	1 drawer	-
SP90D2WH	900	450	442	2 drawer	Top & bottom
SP90D2WHX	900	650	467	2 drawer	Top & bottom
SP120DWH	1200	325	442	1 drawer	-
SP120D2WHSB	1200	450	442	2 drawer	Top & bottom
SP120D2WH	1200	325	442	2 drawer	Side by side/Double Bowl
SP120D2WHX	1200	650	442	2 drawer	Top & bottom
SP150D2SWDB	1500	325	442	2 drawer	Side by side/Double Bowl
SP180D2SWHDB	1800	325	442	2 drawer	Side by side/Double Bowl
SP60D2FL	600	800	442	2 drawer	-
SP90D2FL	900	800	442	2 drawer	-
SP120D2FLSB	1200	800	442	2 drawer	-
SP120D4FLDB	1200	800	442	4 drawer	Double Bowl
SP150D4FLDB	1500	800	442	4 drawer	Double Bowl
SP180D4FLDB	1800	800	442	4 drawer	Double Bowl

NOTES

*Measurements do not include the height or depth of the top. Refer to separate details for height and depth of top.

BASIN TOP - SHARP

14070-KL
Sharp Basin Top 700mm
See page 24

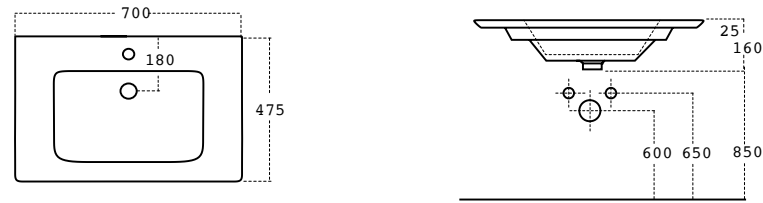

14090-KL
Sharp Basin Top 900mm
See page 24

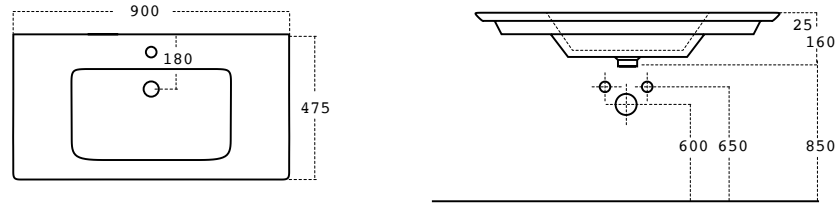

14150-KL
Sharp Basin Top 1040mm
See page 24

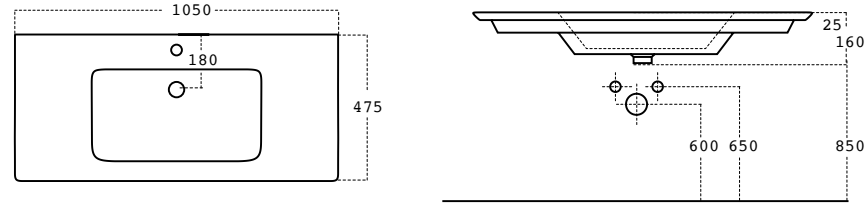

14120-KL
Sharp Basin Top 1200mm
See page 24

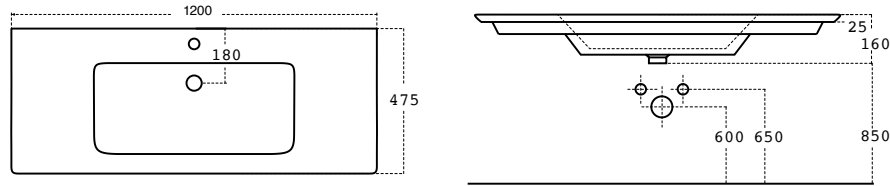

BASIN TOP - DISH

338.E.24629
Dish Basin Top 900mm
See page 26

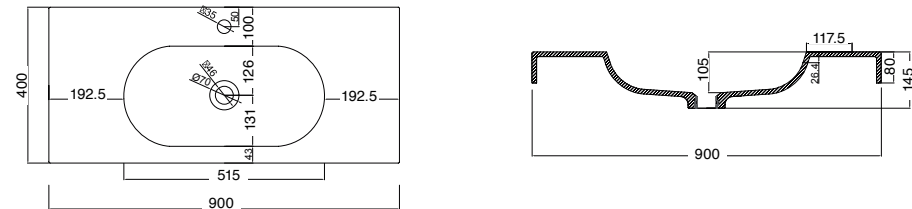

Dish Basin Top 1200mm
See page 26

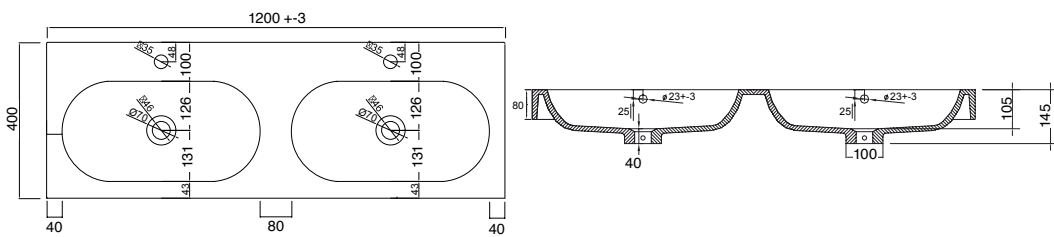

BASIN TOP - FIT

201.E.10750
Fit Basin Top 400mm
See page 30

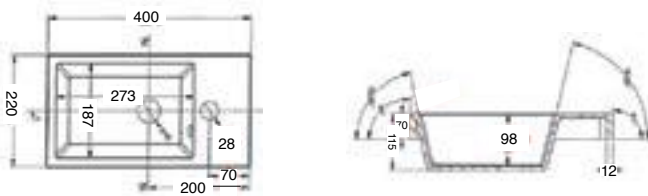

BASIN TOP - ICE

4045-KL
Ice Basin Top 450mm
See page 30



BASIN TOP - FRESH

OA-7545
Fresh Basin Top 750mm
See page 11

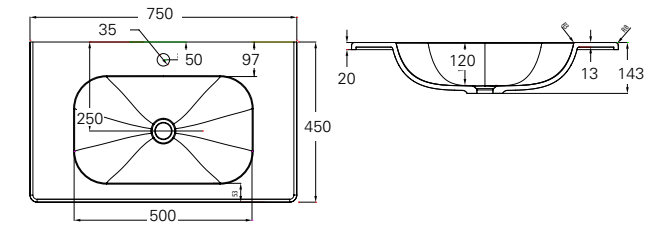

OA-9045
Fresh Basin Top 900mm
See page 13

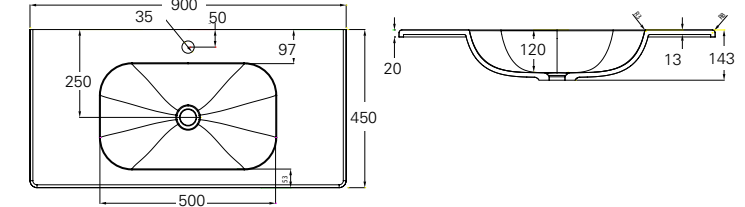

OA-1245
Fresh Basin Top 1200mm
See page 17

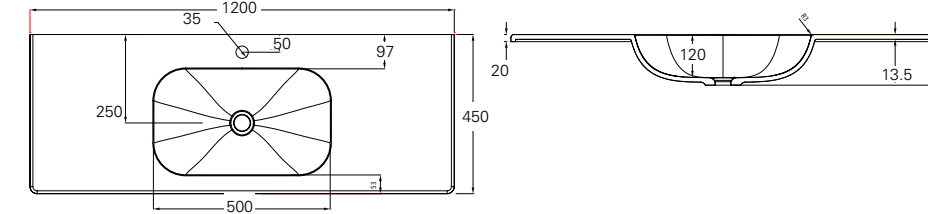

OA-1545
Fresh Basin Top / Double
Bowl 1500mm
See page 21

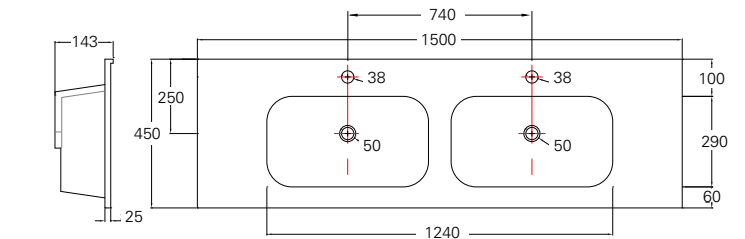

BASIN TOP - PARIS

BNT-538
Paris Basin Top 500mm
See page 28

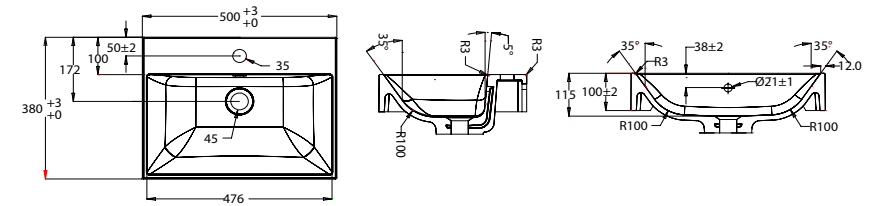

BNT-838
Paris Basin Top 800mm
See page 28

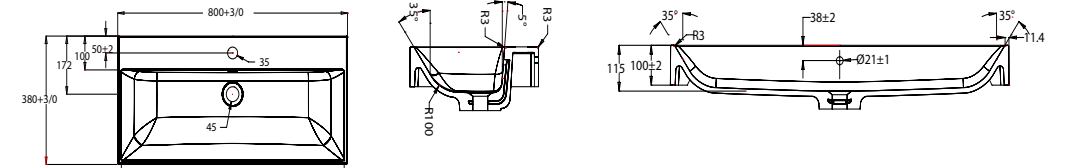

BNT-1038
Paris Basin Top 1000mm
See page 28

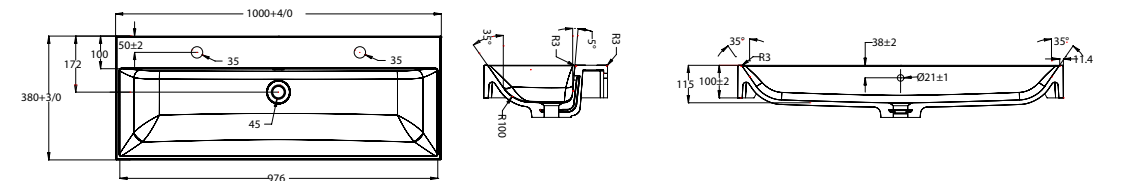

BNT-1238
Paris Basin Top 1200mm
See page 28

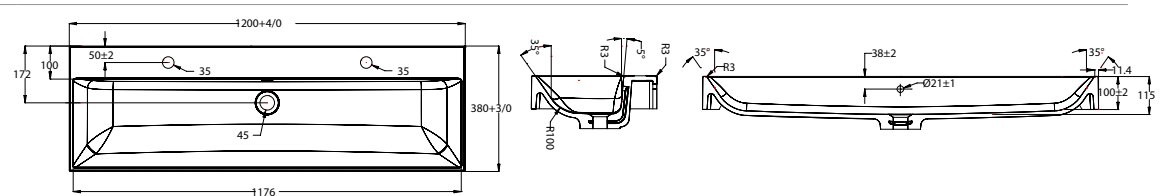

BASIN TOP - SPACE

Z01
Space Basin Top 500mm
See page 31

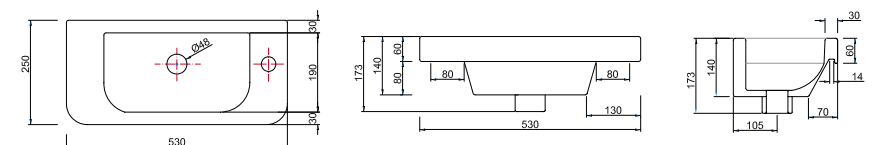

BASIN TOP – SPLASH

1B3.1170
 Splash Basin Top 600mm
 See page 9

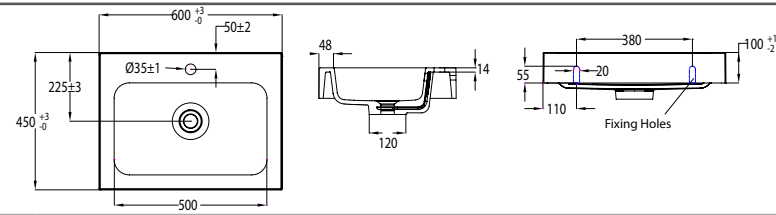

1B3.1171
 Splash Basin Top 900mm
 See page 13

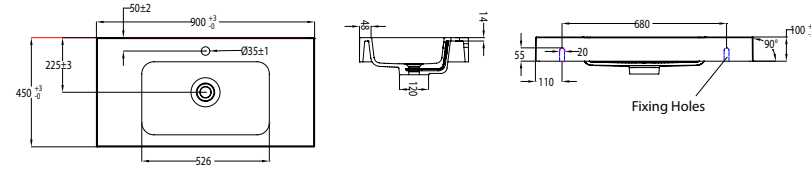

1B3.1316
 Splash Basin Top 1200mm
 See page 17

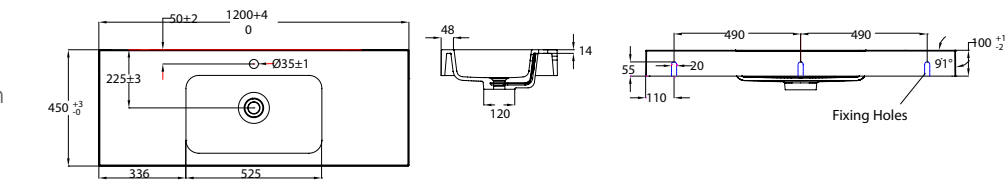

1B3.1173
 Splash Basin Top 1200mm
 Double Bowl
 See page 19

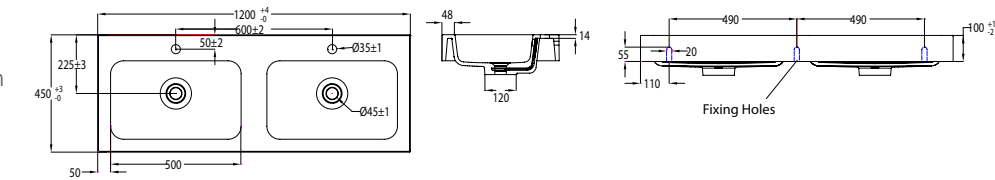

1B3.1314
 Splash Basin Top 1500mm
 Double Bowl
 See page 21

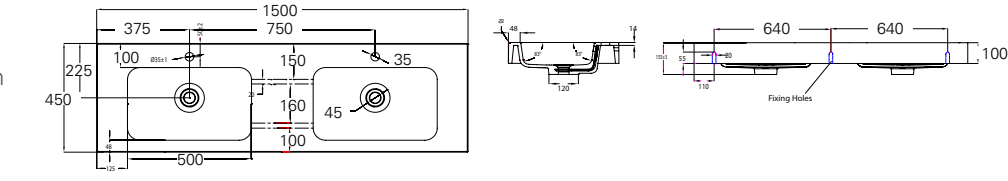

1B3.1315
 Splash Basin Top 1800mm
 Double Bowl
 See page 23

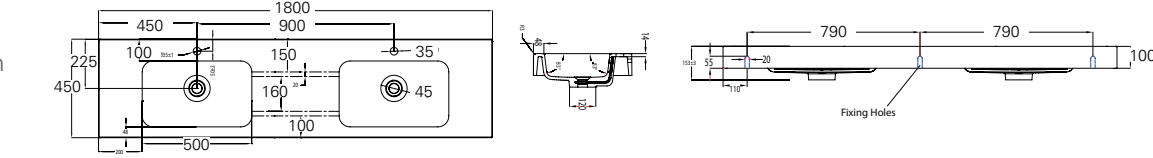

BASIN TOP – ZARA

EP-9060E
 Zara Basin Top 600mm
 See page 9

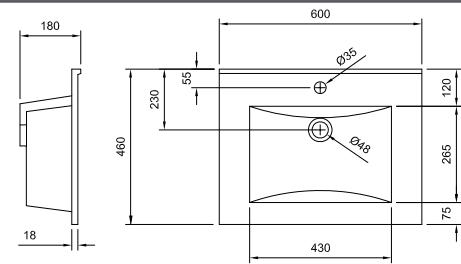

EP-9075E
 Zara Basin Top 750mm
 See page 11

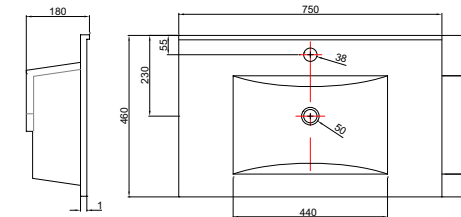

EP-9090E
 Zara Basin Top 900mm
 See page 13

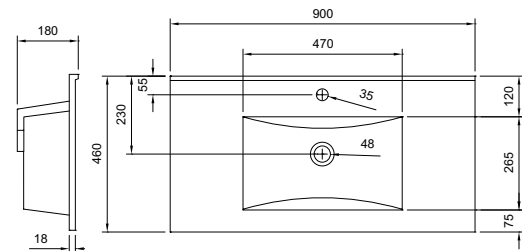

BASIN TOP – ZARA (CONTINUED)

EP-9100E
 Zara Basin Top 1000mm
 See page 15

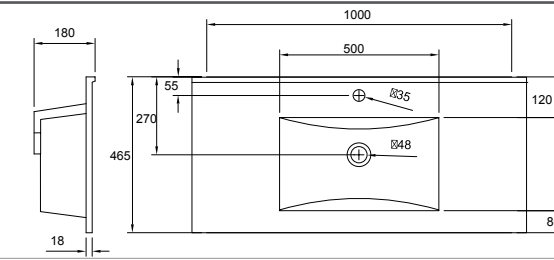

EP-9120E
 Zara Basin Top 1200mm
 See page 17

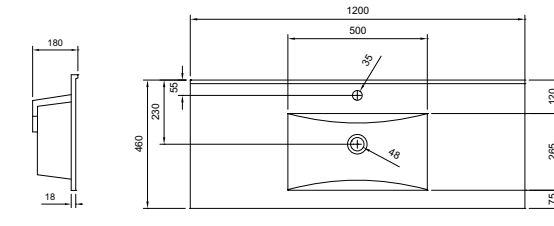

EP-120ED
 Zara Basin Top 1200mm
 Double Basin
 See page 19

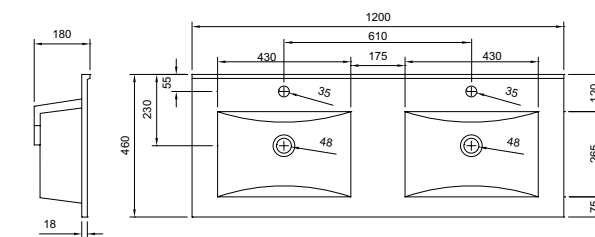

EP-9150E
 Zara Basin Top 1500mm
 See page 21

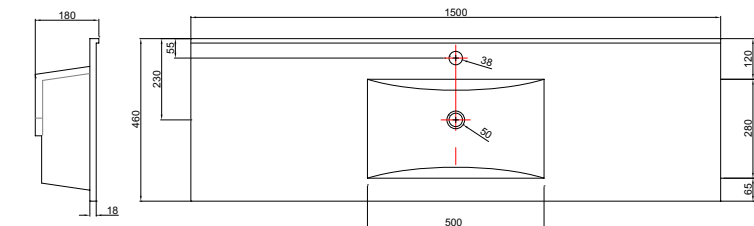

EP-9150ED
 Zara Basin Top 1500mm
 Double Basin
 See page 21

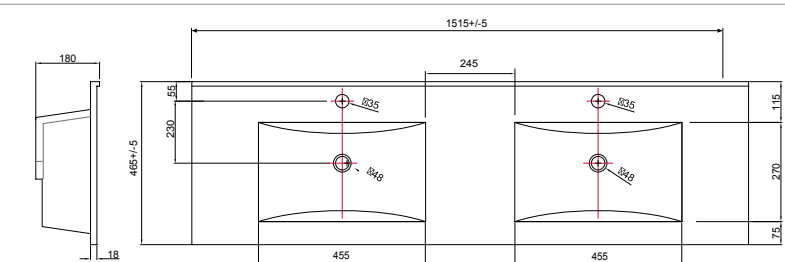

WASH BASINS

B5ECS
 Sonit ClearStone Basin
 See page 36

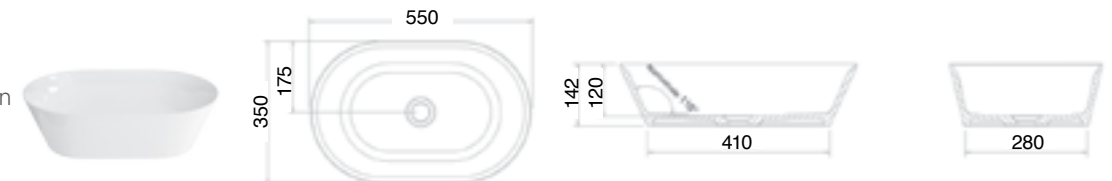

B13ECS
 Puro ClearStone Basin
 See page 36

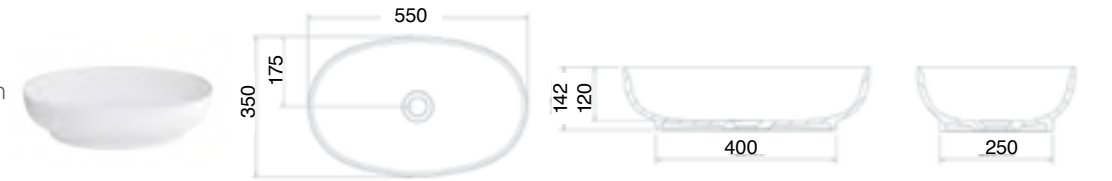

B1ACS
 Form ClearStone Basin
 See page 36

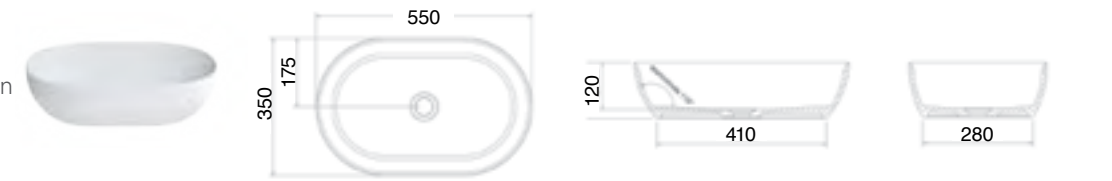

MIKE PRO TAPWARE (CONTINUED)

PROTHERM
Basin 2 hole set,
no waste, chrome
See page 38

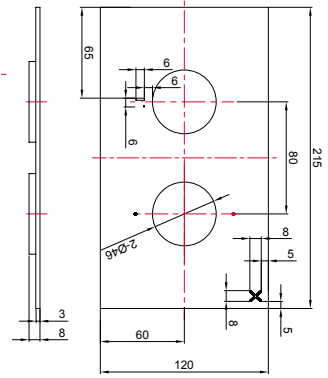

158.G.21387
Shower mixer double
See page 38

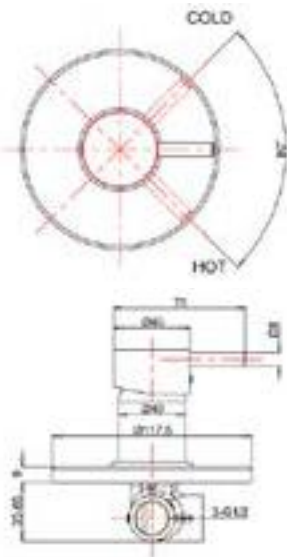

NOTE:
For the each part, the dimension tolerance should be followed the list below.

0 - 100	101 - 200	201 - 400	>401
±1	±2	±3	±5

For the finished assembly, the dimension tolerance should be followed the list below.

0 - 300	≥301
±2	±5

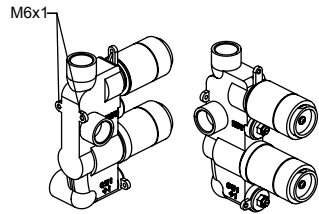

Note:
For each part of the accessory, the dimension tolerance should be followed the list below.

0 - 100	101 - 200	201 - 400	>401
±1	±2	±3	±5

For the finished assembly, the dimension tolerance should be followed the list below.

0 - 300	≥301
±2	±5

SHOWER SETS

CLASS R
Round Shower Set
See page 40

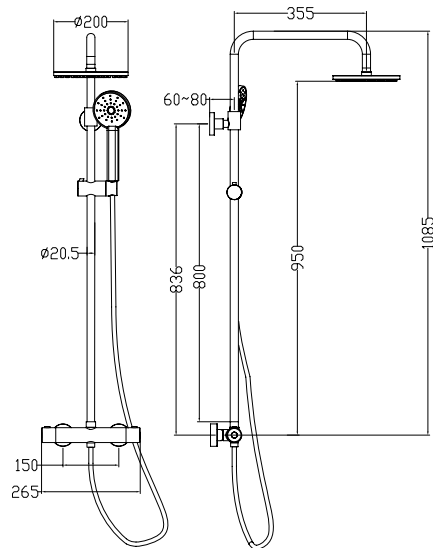

CLASS S
Soft Square
Shower Set
See page 40

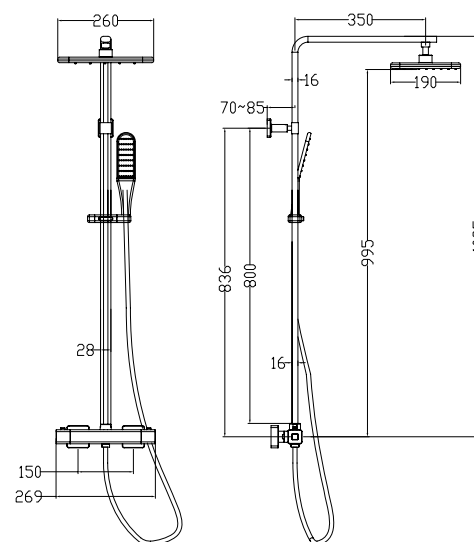

FOXY
Shower Set
See page 40

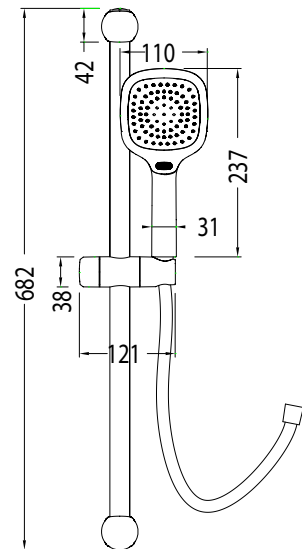

CLASS R

CLASS S

FOXY

NATURAL STONE BATHS

N1A
Form Piccolo
See page 44

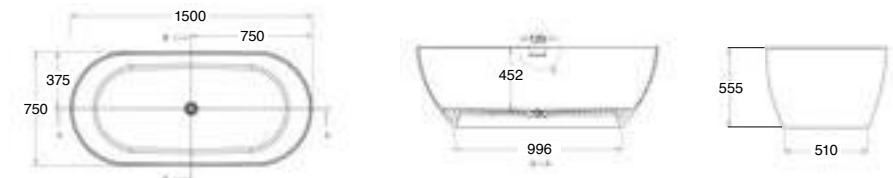

1B1.1311
Form
See page 44

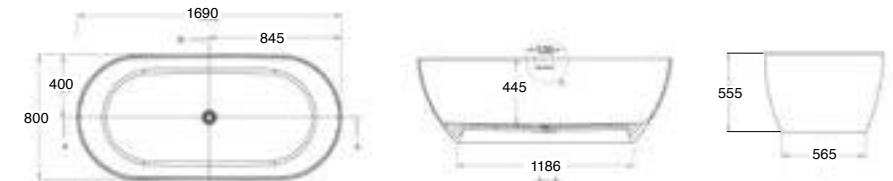

1B1.1310
Sonit
See page 44

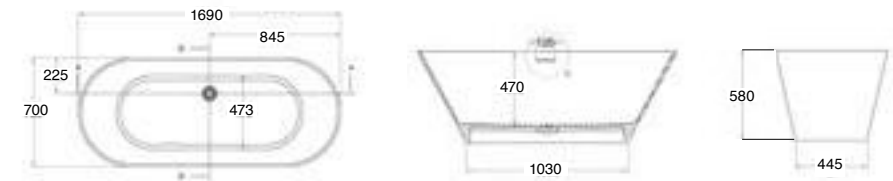

CLEARSTONE BATHS

324.A.21127
Form Piccolo
Clearstone
See page 42

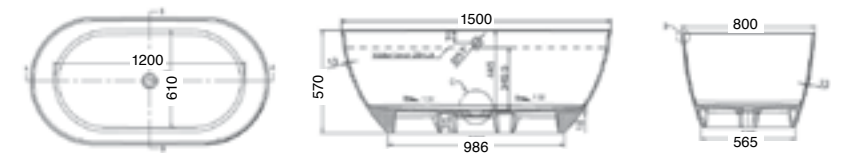

325.A.21128
Form Clearstone
See page 42

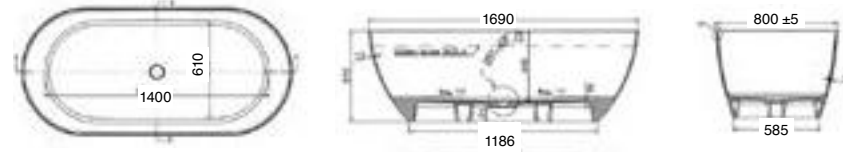

N8ECS
Sonit Clearstone
See page 43

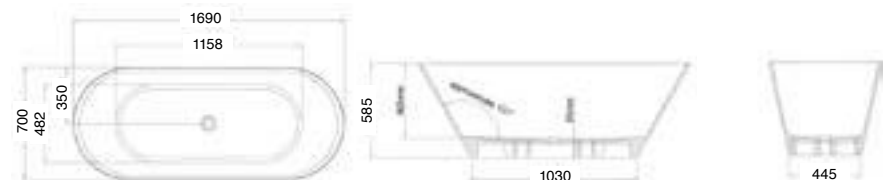

N3ACS
Patinato Petite
Clearstone
See page 43

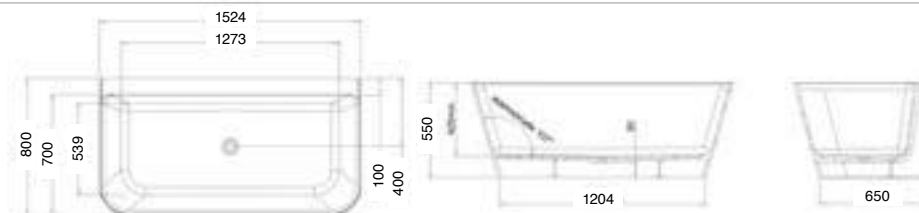

N4ACS
Patinato
Clearstone
See page 43

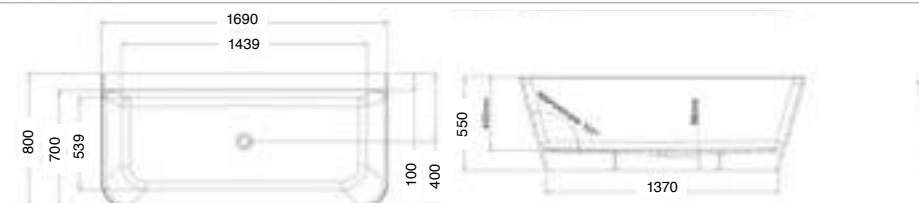

ACRYLIC BATHS

1B1.1430
Saturn bath
See page 45

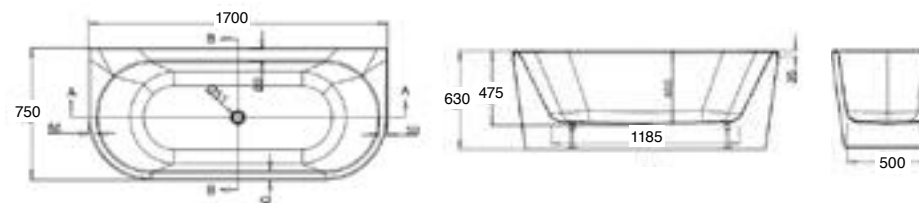

ACRYLIC BATHS (CONTINUED)

319.B.19907
Immerge
See page 45

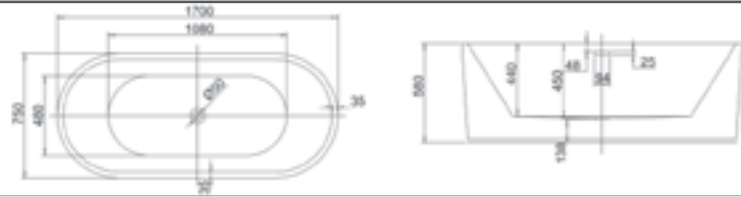

319.B.19909
Loop bath
See page 45

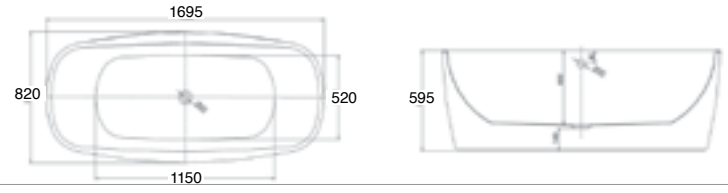

RLG-1500
Mini Tasman bath
See page 45

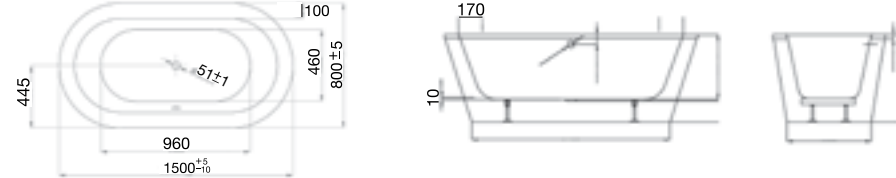

RLG1803
Tasman bath
See page 45

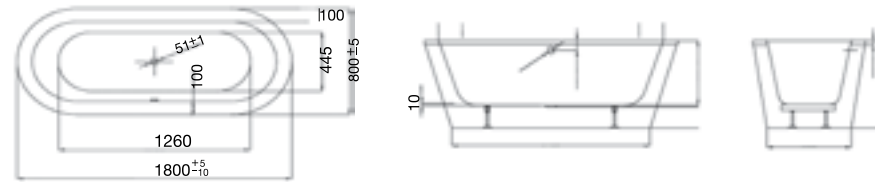

15.B.26772
Lucite Mini bath
See page 45

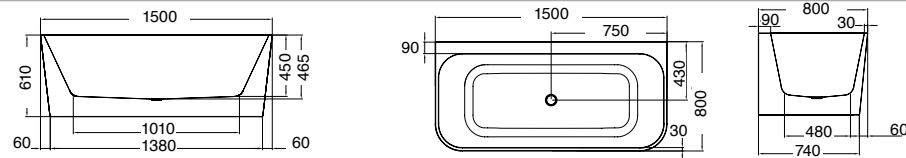

15.B.26725
Lucite bath
See page 45

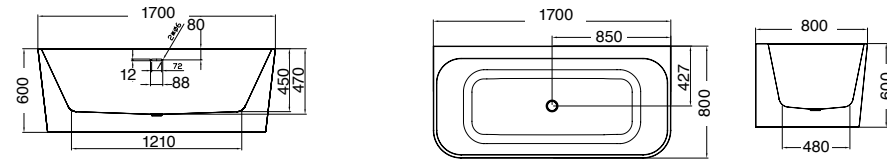

SKIRT BATHS

1b1.1140
Drop Me
1700mm bath
See page 46

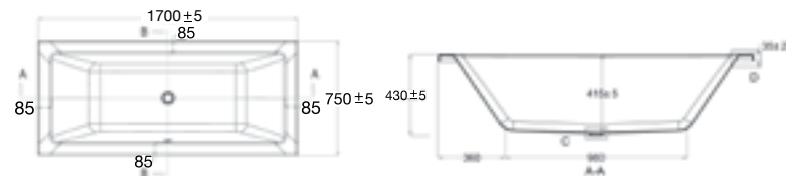

1b1.1141
Drop Me
1800mm bath
See page 46

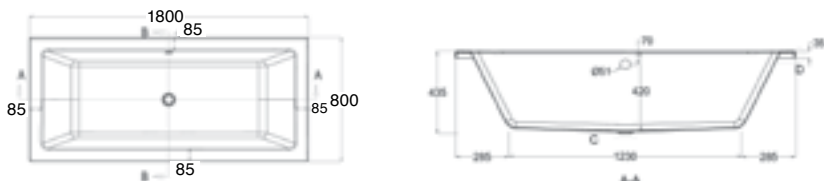

1B1.1148
Drop You
1700mm bath
See page 46

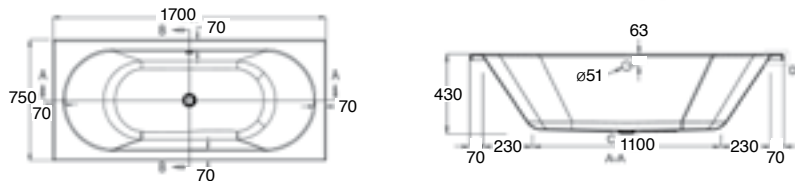

1B1.1149
Drop You
1800mm bath
See page 46

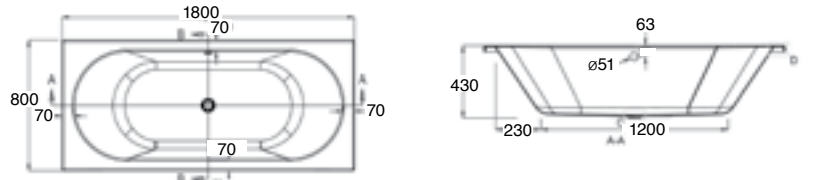

NOTES

SKIRT BATHS: Height does not allow for feet, height for adjustable 110-150mm.

SKIRT BATH PANELS

1B1.1150
1700 Bath Front Panel
See page 46

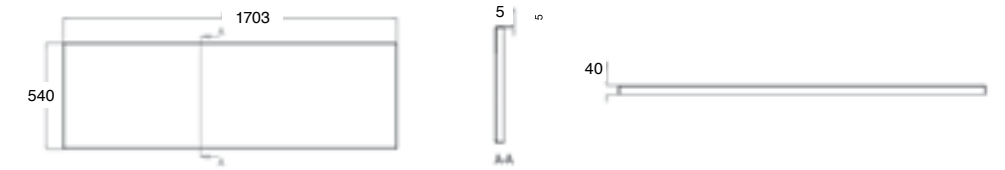

1B1.1152
1800 Bath Front Panel
See page 46

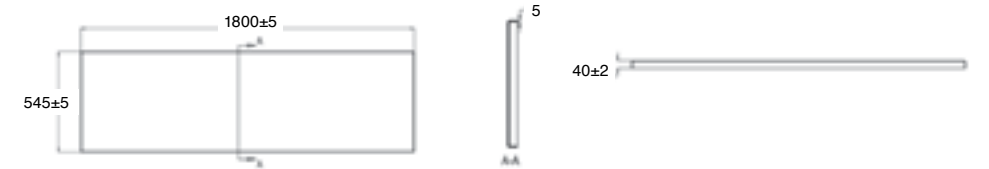

1B1.1151
1700 Bath End Panel
See page 46

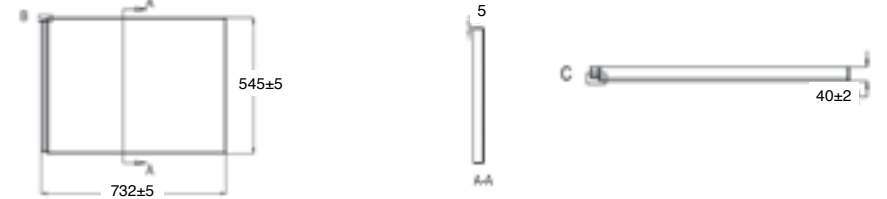

1B1.1153
1800 Bath End Panel
See page 46

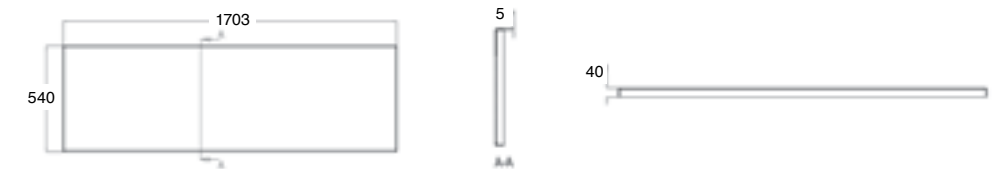

1B1.1142
1700 4-Sided Skirt
See page 46

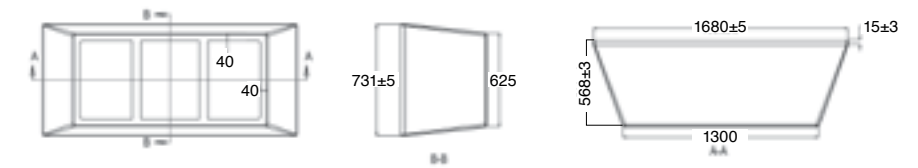

1B1.1143
1800 4-Sided Skirt
See page 46

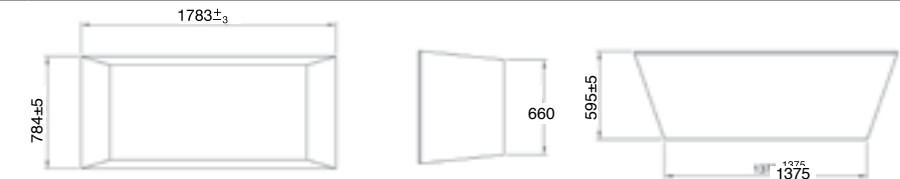

DROP-IN BATH

198.A.19175
Square Drop-in
bath
See page 47

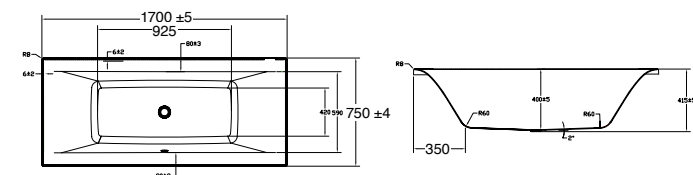

WHIRLPOOLS BATHS

1B1.1146
Whirlpool
1700mm bath
See page 47

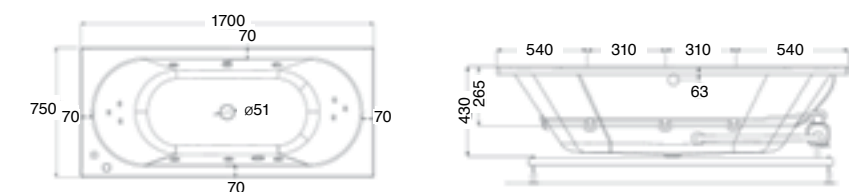

NOTES

SKIRT BATHS: panels & legs

All panel packs are supplied with both a male and female panel and are 100mm high - made from acrylic (not grp). All panel packs are supplied with legs (adjustable in height for leveling) with adjustable telescopic arms. The ends of these arms have a magnetic plate, which marries up with the inside of the panel - you can remove the panel for maintenance, and re-fit very easily. Depending on the size, further legs (adjustable in height for leveling) are included.

WHIRLPOOLS BATHS (CONTINUED)

1B1.1147
Whirlpool
1800mm
bath
See page 47

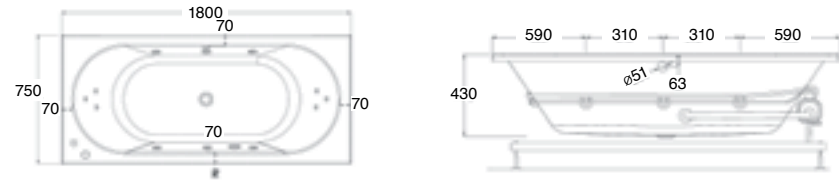

SHOWER BATHS

1B1.1011
Square Shower Bath
Left Hand
See page 49

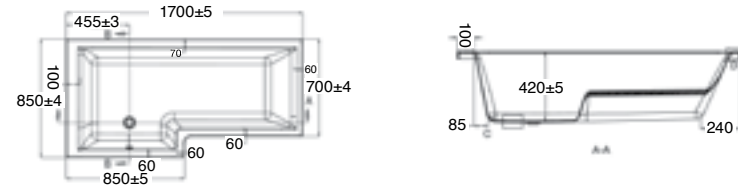

1B1.1012
Square Shower Bath
Right Hand
See page 49

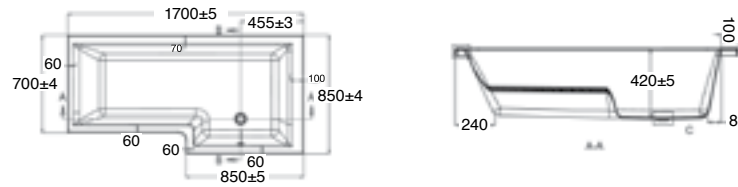

1B1.1013
B Shower Bath
Left Hand
See page 48

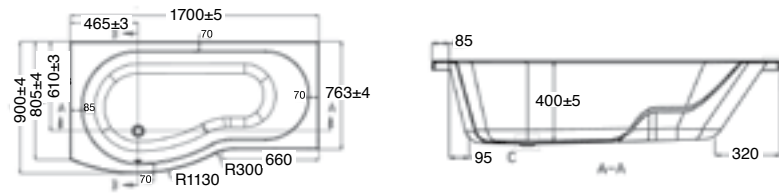

1B1.1014
B Shower Bath
Right Hand
See page 48

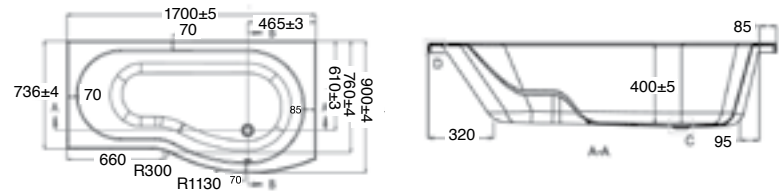

SHOWER BATH PANELS

1B1.1145
Square Shower Bath
End panel
See page 49

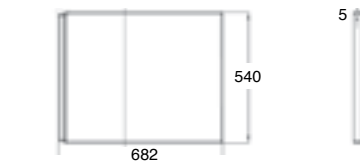

1B1.1144
Square Shower Bath
Front panel
See page 49



1B1.1023
B Shower Bath
End panel
See page 48

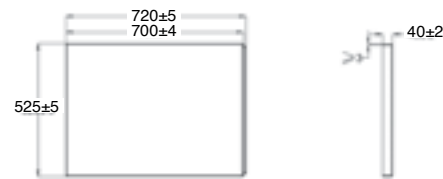

1B1.1024
B Shower Bath
Front panel
See page 48

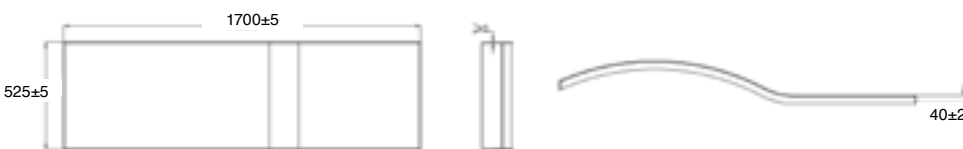

NOTES

SHOWER BATHS: Height does not allow for feet or panels. Height of feet adjustable from 110mm-150mm. Baths cannot be rebated into walls if using the shower screens.

BATH SCREENS

BSL9/L
Eco square
Bath screen -Left
See page 49
NB: Baths cannot be rebated into walls if using the shower screens.

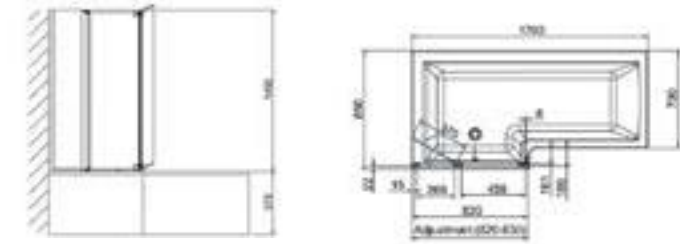

BSL9/R
Eco square
Bath screen -Right
See page 49
NB: Baths cannot be rebated into walls if using the shower screens.

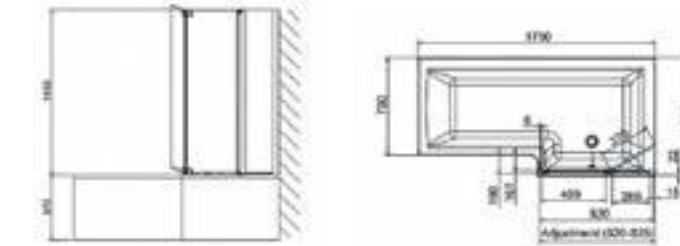

Code	Description	Door Configuration	Measurements	Thickness of Glass	Adjustment	Frame Finish & Glass Pattern
QP99	Bath Screen (squarer pivot panel)	-	W1175 H1500 D1500	6mm	1175-1195	Bright Chrome Clear Glass

NB: Baths cannot be rebated into walls if using the shower screens.

NON STOCK BATHS - NATURAL STONE BATHS

N14
Nebbia
See page 50

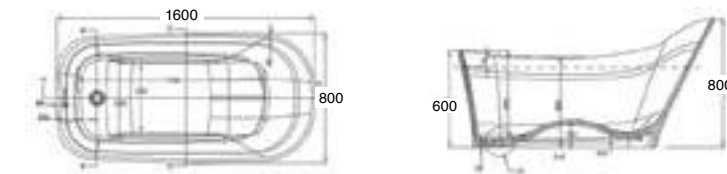

1B1.1410
Palermo
See page 50

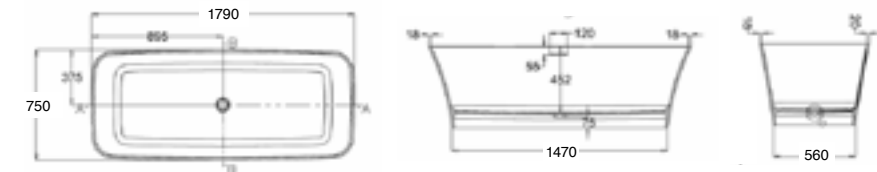

1B1.1411
Palermo Piccolo
See page 50

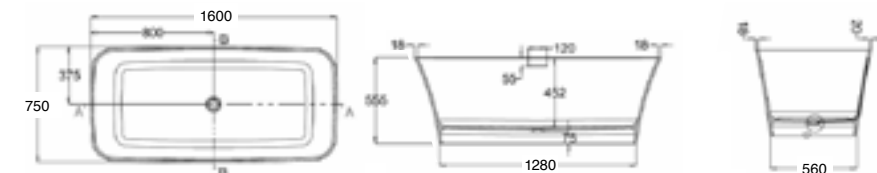

1B1.1412
Vista
See page 50

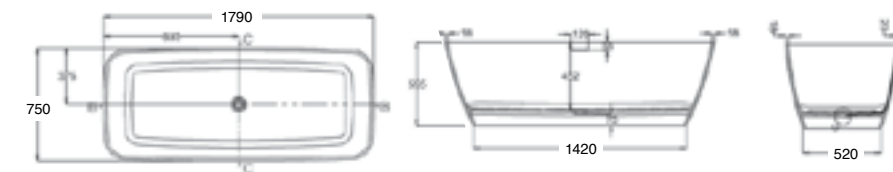

1B1.1413
Vista Piccolo
See page 50

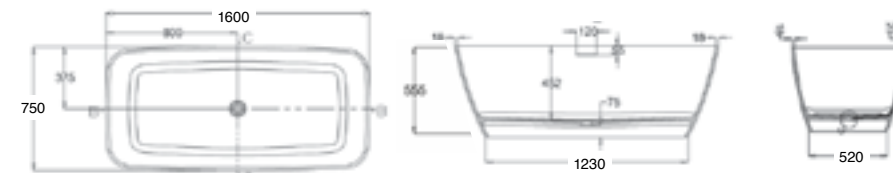

Lonio
See page 50

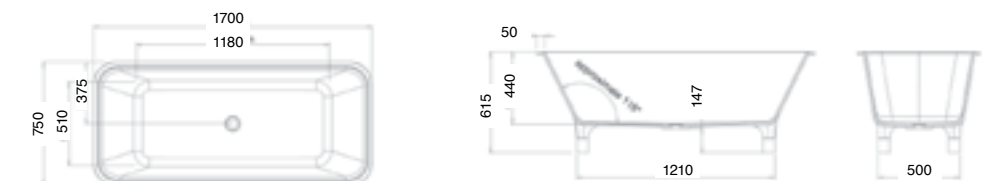

NON STOCK BATHS – CLEARSTONE BATHS

325.A.22272
Teardrop Clearstone
See page 50

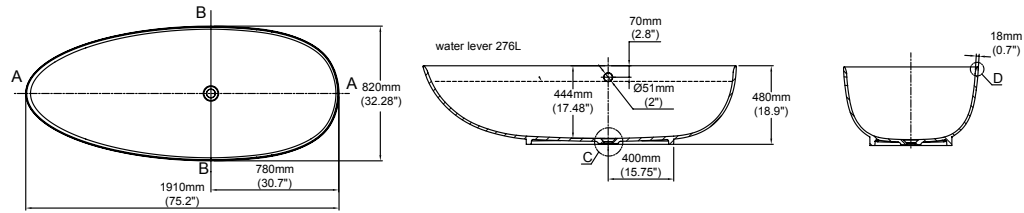

325.A.22271
Teardrop Petite Clearstone
See page 50

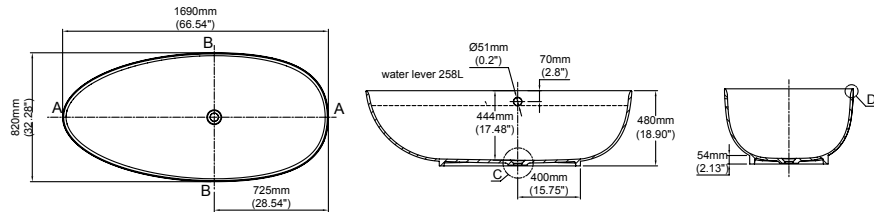

Balthazar Clearstone bath
See page 50

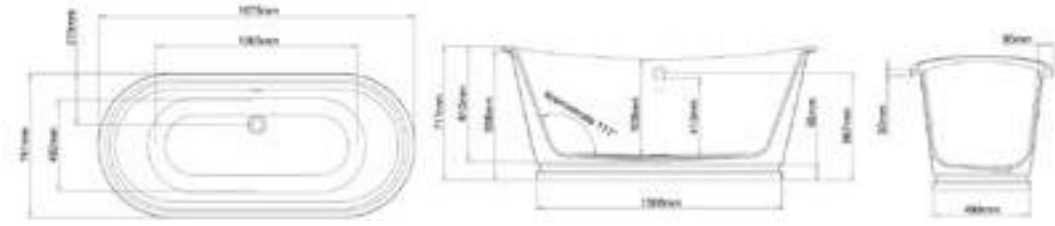

Palermo Clearstone bath
See page 50

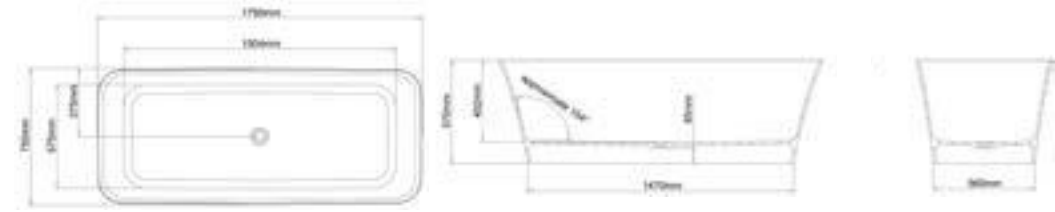

Florence Clearstone bath
See page 50

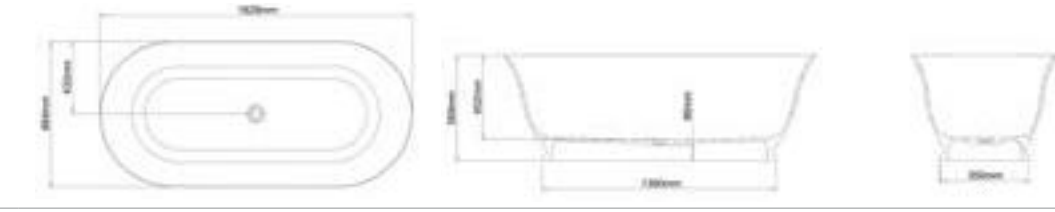

Duo Clearstone bath
See page 50

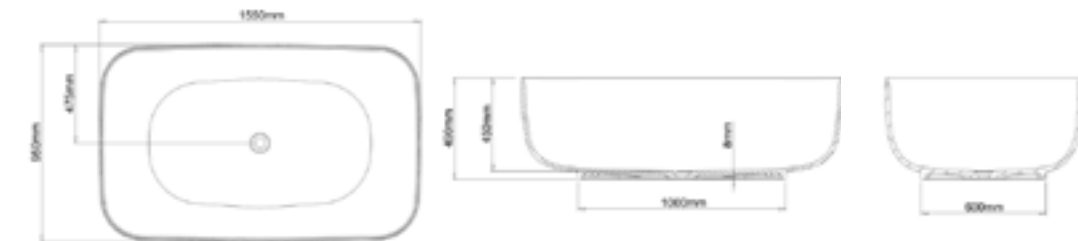

LUCCA INFOLD SHOWERS (See page 53)

Code	Description	Door Configuration	Measurements	Thickness of Glass	Adjustment	Frame Finish & Glass Pattern
16.D.13300	900mm Infold Door	Hinged, Infold Opening	W900 H1950 Door Width 695	6mm	860-890	Satin Silver Chrome Clear Glass
2A1.1456	900mm Side Panel		H1950	6mm	875-890	Satin Silver Chrome Clear Glass
16.D.13301	1000mm Infold Door	Hinged, Infold Opening	W1000 H1950 Door Width 791	6mm	960-990	Satin Silver Chrome Clear Glass
2A1.1457	1000mm Side Panel		H1950	6mm	975-990	Satin Silver Chrome Clear Glass

LUCCA ALCOVE DOORS (See page 54)

Code	Description	Door Configuration	Measurements	Thickness of Glass	Adjustment	Frame Finish & Glass Pattern
16.D.19592	900 x 1950	Swing Door in Recess	W900 H1950 Door Width 672	6mm	870-890	Polished Chrome Clear Glass

LUCCA QUADRANT SLIDING SHOWERS (See page 52)

Code	Description	Door Configuration	Measurements	Thickness of Glass	Adjustment	Frame Finish & Glass Pattern
EQ900	900 x 1950	Sliding Door	W 900 H 1950 Door Entry 480	6mm	870-885	Silver Finish Clear Glass
LC90Q1	900 x 1950	Package	W 900 H 1950 Door Entry 480	6mm	870-885	Silver Finish Clear Glass
EQ1000	1000 x 1950	Sliding Door	W 1000 H 1950 Door Entry 480	6mm	970-985	Silver Finish Clear Glass
LC100Q1	1000 x 1950	Package	W 1000 H 1950 Door Entry 480	6mm	970-985	Silver Finish Clear Glass

ASSISI SHOWERS (See page 56)

Code	Description	Door Configuration	Measurements	Thickness of Glass	Adjustment	Frame Finish & Glass Pattern
Box 1	1000mm Walk-In Front Screen	-	W1000 H2000	8mm	-	Satin Silver Chrome Clear Glass
Box 2	1200mm Walk-In Front Screen	-	W1200 H2000	8mm	-	Satin Silver Chrome Clear Glass
Box 3	1400mm Walk-In Front Screen	-	W1400 H2000	8mm	-	Satin Silver Chrome Clear Glass
Box 4	330mm Walk-In Side Screen	-	W330 H2000	8mm	-	Satin Silver Chrome Clear Glass
Box 5	Walk-In Profile Set	-	H2000	8mm	-	Satin Silver Chrome Clear Glass
Box 6	Walk-In Wall Support Bar	-	W1000	8mm	-	Satin Silver Chrome Clear Glass
Box 7	Walk-In Ceiling Support	-	H2750	8mm	-	Satin Silver Chrome Clear Glass

CENTRAL SHOWERS (See page 58-59)

Code	Description	Door Configuration	Measurements	Thickness of Glass	Adjustment	Frame Finish & Glass Pattern
16.D.11488	1160x1950	Single Hung, Sliding Door	W 1200 H 1950 Door Width 480	8mm	1160-1190	Silver Finish Clear Glass
16.D.11489	1360 x 1950	Single Hung, Sliding Door	W 1400 H 1950 Door Width 580	8mm	1360-1390	Silver Finish Clear Glass
16.D.11329	1560x1950	Single Hung, Sliding Door	W 1600 H 1950 Door Width 580	8mm	1560-1590	Silver Finish Clear Glass
16.D.12140	1660x1950	Single Hung, Sliding Door	W 1700 H 1950 Door Width 730	8mm	1660-1690	Silver Finish Clear Glass
16.D.11480	1160x1950	Double Hung, Sliding Door	W 1200 H 1950 Door Width 403	8mm	1160-1190	Silver Finish Clear Glass
16.D.11490	775x1950	Side Panel	W 800 H 1950	8mm	775-790	Silver Finish Clear Glass
16.D.11491	875x1950	Side Panel	W 900 H 1950	8mm	875-890	Silver Finish Clear Glass
16.D.12143	975x1950	Side Panel	W 1000 H 1950	8mm	975-990	Silver Finish Clear Glass

LUCCA SHOWERS (See page 55)

Code	Description	Door Configuration	Measurements	Thickness of Glass	Adjustment	Frame Finish & Glass Pattern
16.D.13045	760 x 900 Rectangle	-	W725 H1950 D865	6mm	725-750 865-890	Bright Chrome Clear Glass
16.D.13044	900 x 760 Rectangle	-	W865 H1950 D725	6mm	865-890 725-750	Bright Chrome Clear Glass
16.D.12144	900 x 900 Square	-	W865 H1950 D865	6mm	865-890	Bright Chrome Clear Glass
12.D.13043	1000 x 1000 Square	-	W965 H1950 D965	6mm	965-990	Bright Chrome Clear Glass

NOTES

Assisi Showers: These showers are best suited to wet room installation. Please check with installers/local regulations for suitability.

ACRYLIC SHOWER TRAYS

BSF-9076S
Rectangle Shower Tray
See page 60-61

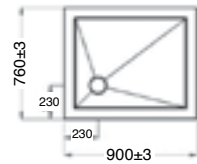

BSF-9090R
Quadrant Shower Tray
See page 60-61
NB: Waste & curve only available as indicated.

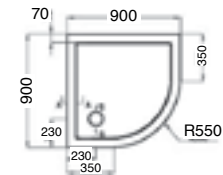

BSF-1000R
Quadrant Shower Tray
See page 60-61
Note: Waste & curve only available as indicated.

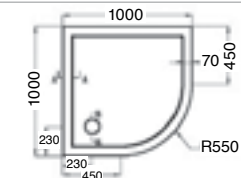

BSF-1290L/BSF-1290R
Offset Shower Tray
See page 60-61
Available as left-hand or right-hand curve.
BSF-1290L pictured

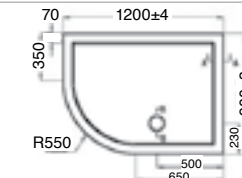

BSF-1290S
Rectangle Shower Tray
See page 60-61

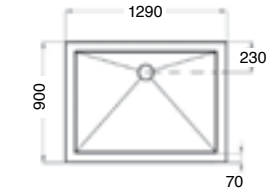

1B2.1305
Rectangle Shower Tray
See page 60-61

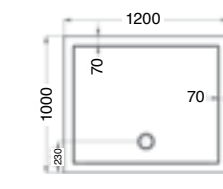

BSF-1490
Walk-In Shower Tray
See page 60-61

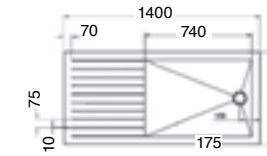

BSF-1490C
Rectangle Shower Tray
See page 60-61

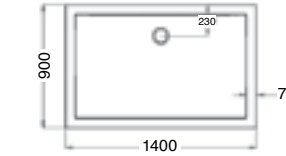

1B2.1304
Rectangle Shower Tray
See page 60-61

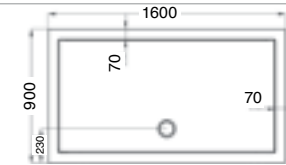

BSF-1600
Walk-In Shower Tray
See page 60-61

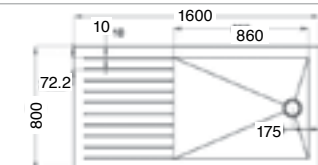

BSF-1780
Walk-In Shower Tray
See page 60-61

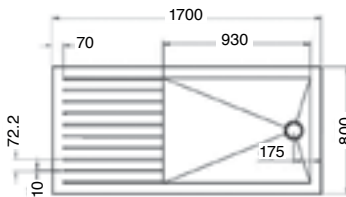

1B2-1309
Rectangle Shower Tray
See page 60-61

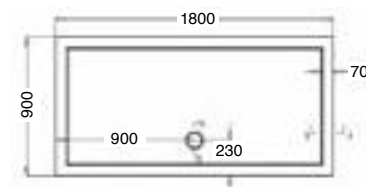

1B2-1345
Rectangle Shower Tray
See page 60-61

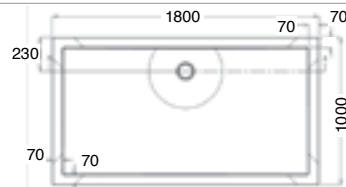

1B2.1343
Rectangle Shower Tray
See page 60-61

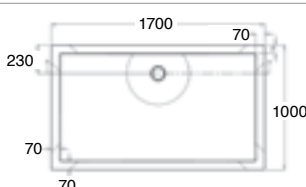

1B2.1342
Rectangle Shower Tray
See page 60-61

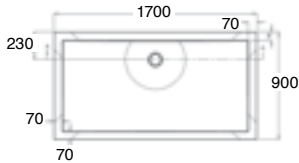

Z1175
Rectangle Shower Tray
See page 60-61

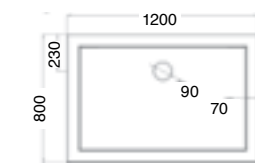

ACRYLIC SHOWER TRAYS WITH UPSTANDS

Z1409
Square Shower Tray with Upstand (2 Sides)
See page 61

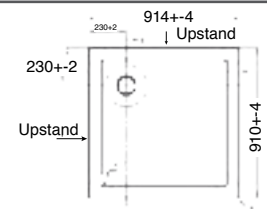

Z1410
Square Shower Tray with Upstand (3 Sides)
See page 61

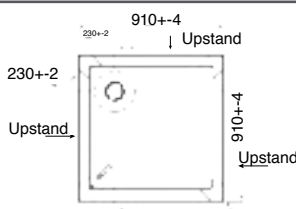

Z1411
Square Shower Tray with Upstand (2 Sides)
See page 61

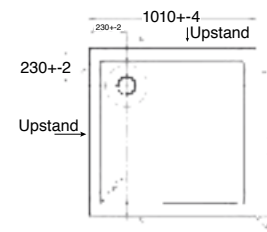

Z1412
Square Shower Tray with Upstand (3 Sides)
See page 61

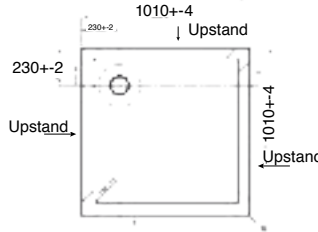

ONDA TOILETS

OZ306
Onda close coupled toilet suite with cistern, lid and soft-close seat
Back inlet water.
See page 65

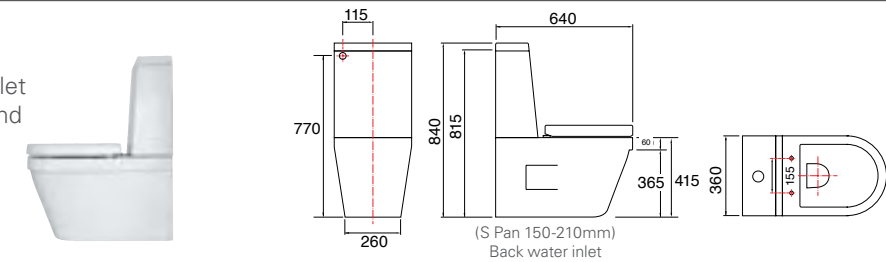

OZ266*
Onda close coupled toilet suite with one-piece cistern and soft-close seat side.
See page 65

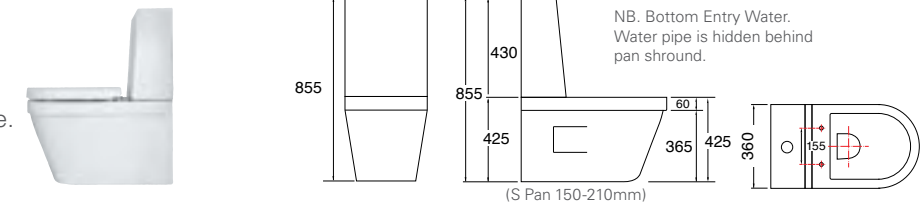

OZ15-PS
Onda wall-hung pan with soft-close seat
See page 65

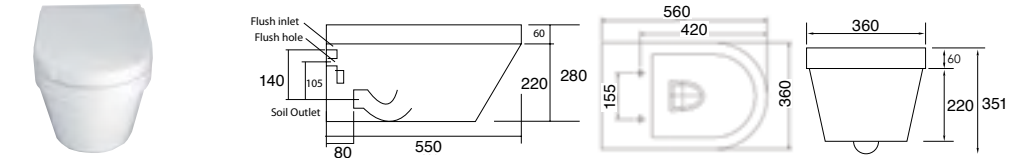

OZ14**
Onda back to wall pan with soft-close seat.
See page 65

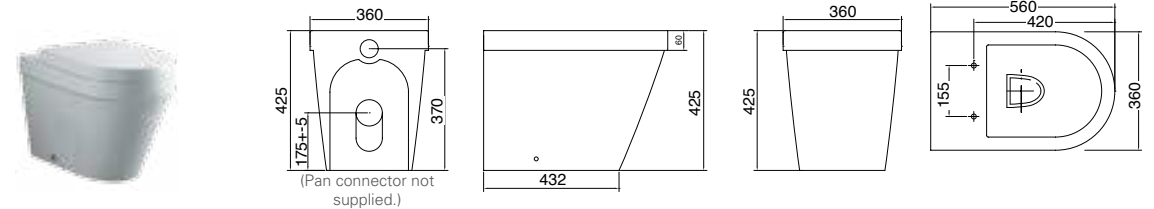

Z22
Onda back to wall bidet
See page 65

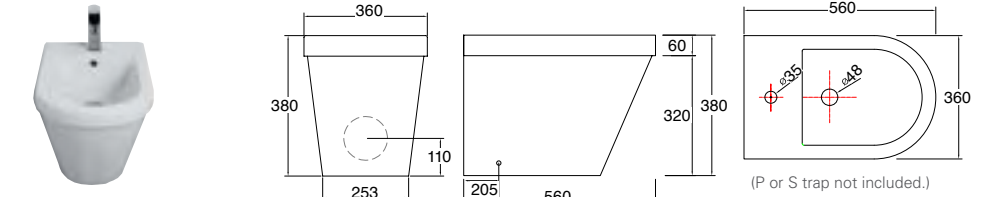

FLUSH PLATES

3D1.1006
White
3D1.1007
Chrome High Gloss
3D1.1008
Chrome Matt
In-Wall Cistern face plate
See page 68

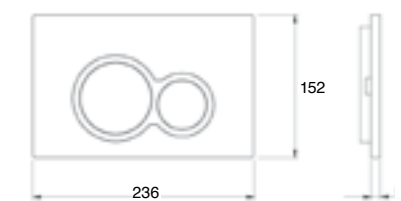

3D1.1009
White
3D1.1010
Chrome High Gloss
3D1.1011
Chrome Matt
In-Wall Cistern face plate
See page 68

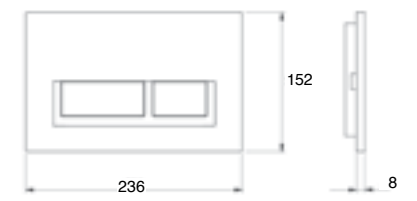

IN-WALL CISTERNS

3D1.1004
In-wall cistern with steel frame.
Adjustable dual flush valve and height frame. See page 68

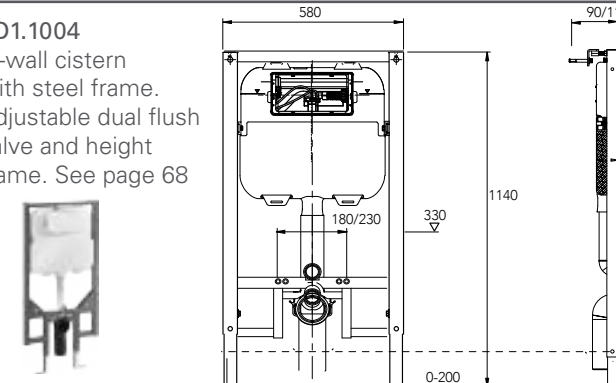

3D1.1005
In-wall cistern.
Adjustable dual flush valve.
See page 68

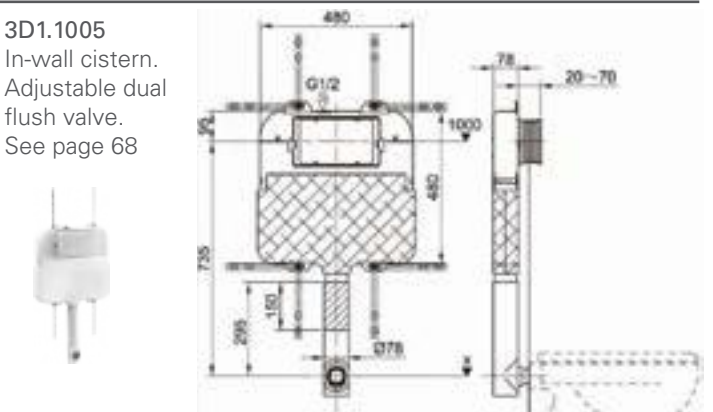

NOTES

ONDA TOILETS:
NB: Toilets must be fitted to 100mm soil pipe.
*Wingback location is 200mm high x 100mm from centre of waste outlet right-hand side.
**140-160mm adjustment with STC converter. Pan converter (Code: STC) available at an extra charge.

FINE ANGLED & FINE ROUND TOILETS

S40-6834*

Fine angled toilet suite
/One-piece cistern with angled soft-close seat and lid.
See page 66

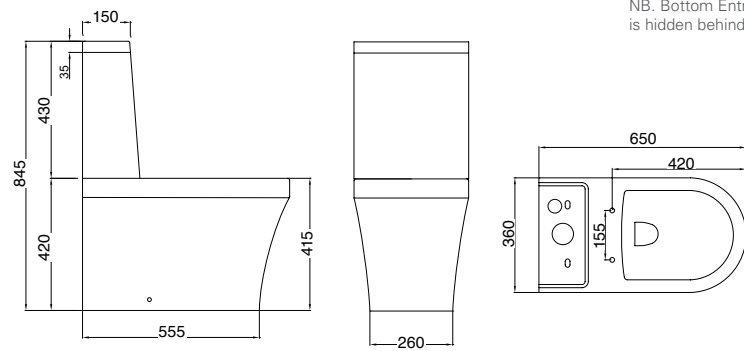

NB. Bottom Entry Water. Water pipe is hidden behind pan shroud.

S40-6881*

Fine round toilet suite
/One-piece cistern with round soft-close seat and lid. See page 67



S40-6880*

Fine angled toilet suite
/Two-piece cistern with angled soft-close seat and lid.
See page 66

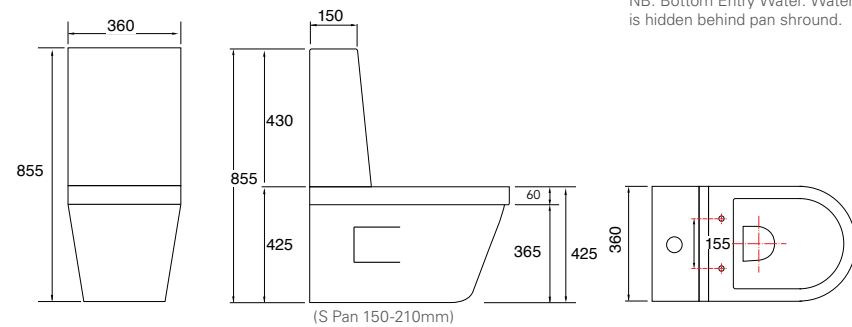

NB. Bottom Entry Water. Water pipe is hidden behind pan shroud.

S40-6836*

Fine round toilet suite
/Two-piece cistern with round soft-close seat and lid. See page 67



S40-6927

Fine angled wall-hung toilet
with angled soft-close seat.
See page 66

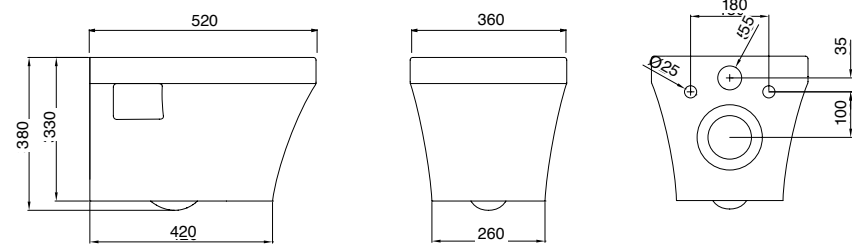

S40-6926

Fine round wall-hung toilet
with round soft-close seat.
See page 67



S40-7127

Fine angled back to wall
pan with angled soft-close
seat.
See page 66

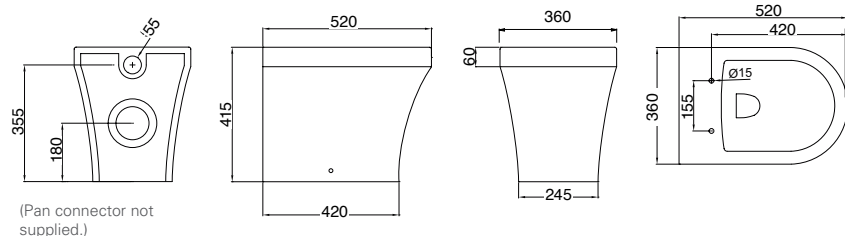

(Pan connector not supplied.)

S40-7126

Fine round back to wall pan
with round soft-close seat.
See page 67



40-1972

Fine round back to wall
bidet
See page 67

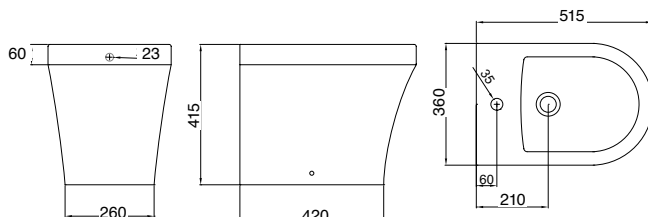

NOTES

FINE ANGLED & FINE ROUND TOILETS:

NB: Toilets must be fitted to 100mm soil pipe.

*Wingback location is 200mm high x 100mm from centre of waste outlet right hand side.

S40-6836 : Use Onda OZ306 specification drawing for water connection.

INSTALLATION TIPS

- All products must be inspected before installation. VCBC is not liable for installation costs.
- Before installing, ALWAYS read the accompanying installation notes.
- Any wall to which a product is fixed must be of suitable construction to support that product's weight.
- To assist with future maintenance, it is strongly recommended that furniture and ceramics be fitted to a tiled surface (rather than butting tiles against an item).
- The glaze used on VCBC's ceramic products is tough and non-porous. However, it must not be put under undue stress which may cause crazing or other damage:
 - ~ Do not over-tighten the waste – hand-tighten only with the correct sealant and contoured waste
 - ~ Do not over-tighten tapware during installation
 - ~ Water temperature should not exceed 55°C
 - ~ Do not drop anything onto a glazed surface
- To avoid damage, tapware and showers MUST have the appropriate inline filters, and water pressure should not be no more than 500kPA.
- To avoid deterioration, it is important that mirrors are kept dry of any moisture, especially along edges. (Refer to instructions for the appropriate cleaning method.)
- Cleaning products are to be used as per instructions. Use a moist soft cloth, micro fibre cloth or a diluted mild detergent. Never use products containing acids, bleach or caustic soda. Never use cleaners of a gritty, abrasive nature.
- Ceramic products are fired in a kiln, then cooled – a process which causes shrinking. Therefore, items may not be perfectly square or flat. Each product is checked to ensure it meets strict tolerances before dispatch.
- Toilet must be fitted to 100mm soil pipe.

PRICING

Price quoted in our price list are for white only or Timber effect Melamine finish. Note: some colour may vary from samples.

TAP HOLE

All tops and basins are quoted with one tap hole. Please ask for pricing on other configurations.

DELIVERY

We aim to despatch all standard orders within five days of receipt of the order. Imported products, timber finishes, paint colours, and other non-standard items may be subject to a longer delivery date. We will keep you informed if this occurs.

FREIGHT

Freight will be charged for orders under \$400.

DISCLAIMER

Smail & Co retain the right to change products and specifications without notice. All measurements are in millimeters and are nominal only. We do not refund if you change your mind. If the goods are faulty, however, we will meet our obligations under the Consumer Guarantees Act.

NON STOCK ITEMS

Products made to order take longer to deliver.

WARRANTY

General Warranty Statement

Smail & Company Limited (Smail & Co) warrants that in the manufacture of its Bath Co products only high quality workmanship and materials have been used.

The following warranty applies to Bath Co products supplied to customers in New Zealand, for use in residential installations only.

Subject to the warranty conditions, in addition to any other right or remedy that the purchaser may have under any relevant consumer protection legislation, Smail & Co undertakes to either **repair or replace** (at its discretion) any Bath Co product if that product contains a **material defect** with either **materials or workmanship** which arose in the **course of manufacture**.

Residential Warranty

- In relation to the following products bathroom vanities, basins, tops, baths, toilets, showers, tapwares a 5-year warranty applies to from date of purchase.
- In relation to the following products shower hoses, shower heads, cartridges, mirrors, cistern fittings, wastes, toilet seats, electrical, face plates, washers, valves and shower seals a 1-year warranty applies to from date of purchase.
- In relation to the following products in-wall cisterns (excluding items listed above) a 15-year warranty applies to from date of purchase.

Commercial Warranty

In relation to any Bath Co products installed in a commercial situation a 12 month warranty applies from the date of purchase. Commercial situations are defined as public washrooms, public buildings, schools, sports centres, gymnasium, hospitals, motels, hotels and retirement villages.

Warranty Conditions

Smail & Co's domestic/residential warranty and commercial warranty is subject to the following conditions:

- Proof of purchase (such as invoice or receipt) must be provided by the initial purchaser. This warranty is not transferable.
- All Bath Co installation instructions must have been strictly followed and the product must have been installed in accordance with the relevant New Zealand Building/Plumbing Codes by a certified building or plumbing practitioner (as appropriate for the product).
- The product must not have been subject to excessive wear and tear. The warranty only covers normal use and typical wear and tear.
- The product must not have been tampered with or repaired in any way other than in accordance with this warranty.
- The product must not have been damaged by misuse, accident or neglect, including water damage, sunlight, excessive water temperature, humidity, direct lighting or other adverse environmental conditions.
- Harsh detergents or abrasive cleaners must not have been used on the product and the product must be cleaned in accordance with the recommended cleaning methods.
- All warranty covered repair work is to be performed by Smail & Co but Smail & Co shall not be responsible for the cost of removal or installation of the product.
- Smail & Co shall make the final determination on any issue or uncertainty regarding the application of this warranty.
- If you acquired the Bath Co product in trade (or some other exception exists under the Consumer Guarantees Act 1993 (the Act)) then the Act shall not apply.

If the above conditions are not met, the warranty will be null and void.

Smail & Co shall not be liable to the purchaser for any loss, damage (direct, indirect or consequential), cost or expense incurred by the purchaser (including, without limitation, any damage to other products and/or labour costs incurred in the installation, repair or replacement of the product) other than in accordance with the above warranty, under any relevant consumer protection legislation or as consented in writing by Smail & Co in advance of the cost being incurred.

