

## DESCRIPTION

Zero 900 - 1 Drawer plus 1 Concealed Drawer, White Unit, Kordura Top

## PRODUCT CODE

ZE90DWHA



## FEATURES

- Dimensions - W 890 x H 525 x D 500 mm
- Available in White paint (Gloss/Matt<sup>^</sup>), Timber Veneer,<sup>\*</sup> or in your choice of paint colour.<sup>^</sup>
- The paint used on our products is polyurethane or UV based. It is five times harder and more durable than lacquer finishes.
- Timber veneer finishes are 100% natural, so each have variations in grain and colour. All come stained and sealed with a protective UV finish.
- Kordura tops<sup>\*\*</sup> are 25mm thick, available in White, also available in colours (additional cost).
- Soft-close drawers. NZ-made cabinetry.
- Pair with our one of our Undermount, Semi-Recessed or Counter Top basins.

## PAINT<sup>^</sup> / TIMBER VENEER<sup>\*</sup> FINISHES

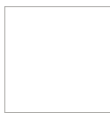

White Paint  
(Gloss or Matt)



White Oak



Blonde Oak

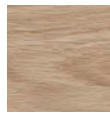

Natural Oak

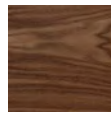

Walnut



Chestnut

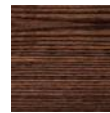

Coffee



Noce



Dark Oak



Custom Paint  
(Gloss or Matt)

## KORDURA TOP FINISHES<sup>\*\*</sup>



White



Carrara  
Marble

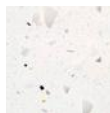

Ice  
Crystal



Peak  
Stone



Black  
Granite

## TECHNICAL DRAWINGS

See reverse.

## NOTES

- \*Non-stock item. • <sup>^</sup>15% surcharge applies on Custom Paint Colours (Gloss/Matte), and Matte White paint finish, **25%** for Metallic and Black (Gloss/Matte).
- For basin options refer to the Michel César catalogue • 1500 + 1800mm vanities with single bowls must be offset left or right.

**\*\*KORDURA TOPS** • 15% surcharge applies for coloured Kordura tops (excludes White) • Tap holes do not come pre-drilled – this is the responsibility of the installer, and can be cut with a hole saw, jigsaw or router. December 2019.

## DESCRIPTION

Zero 900 - 1 Drawer plus 1 Concealed Drawer, White Unit, Kordura Top

## PRODUCT CODE

ZE90DWHA

## TECHNICAL DRAWINGS

Top

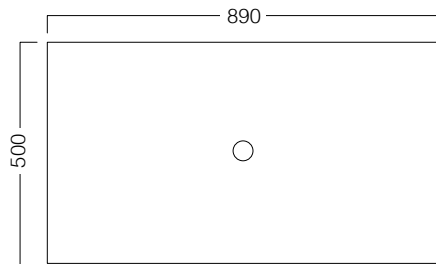

Section of Drawer

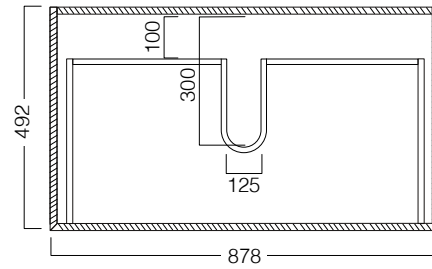

Front

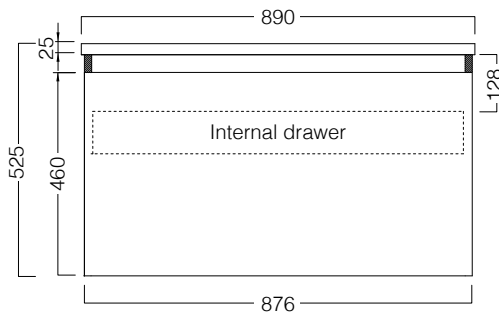

Side Section

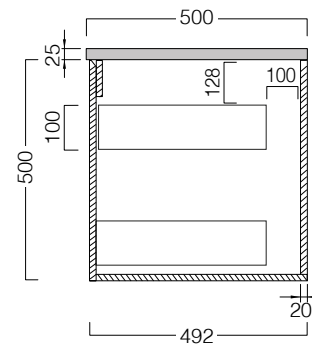

## NOTES

• Must use bottle traps to ensure drawers open, we recommend 40551-32 bottle trap. • Please use a contoured waste with all china basins. We recommend A27, PUW68R or FT41045 wastes. • Drawing indicates the technical measurement only and is not a reflection of how the product will look. Sizes nominal only. Drawings in millimetres. Not to scale. December 2019.