

DESCRIPTION

Twenty 1210 Wall Hung, 2 Drawer, Double Bowl, White / Timber Veneer

PRODUCT CODE

TW121D2DBWH / T



FEATURES

- W1210 x H626 x D480 mm
- Available painted White, in Timber Veneer*, or in your choice of paint colour.^
- The paint used on our products is polyurethane or UV based. It is five times harder and more durable than lacquer finishes.
- Timber veneer finishes are 100% natural, so each have variations in grain and colour. All come stained and sealed with a protective UV finish.
- Four bowl options – left, right, centre and total.
- Handles can be white painted, in Natural Oak or Dark Oak timber veneers.
- Soft-close drawers.
- Italian-made, ceramic top. NZ-made cabinetry.

PAINT / TIMBER VENEER FINISHES*



White Paint

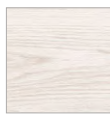

White Oak



Blonde Oak

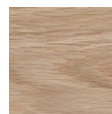

Natural Oak



Walnut

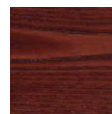

Chestnut

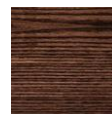

Coffee



Noce



Dark Oak

NOTES

Please see reverse for technical drawings.

*Non-stock item. ^15% surcharge applies for custom paint colour, 25% for metallic and black gloss.

DESCRIPTION

Twenty 1210 Wall Hung, 2 Drawer, Double Bowl, White / Timber Veneer

PRODUCT CODE

TW121D2DBWH / T

TECHNICAL DRAWINGS

Top

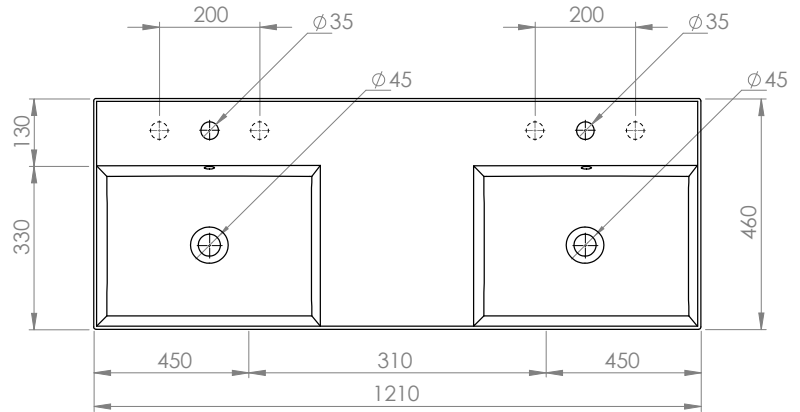

Side Section AA

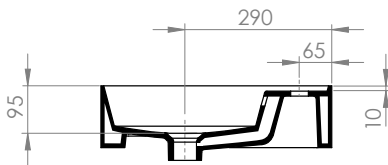

Back

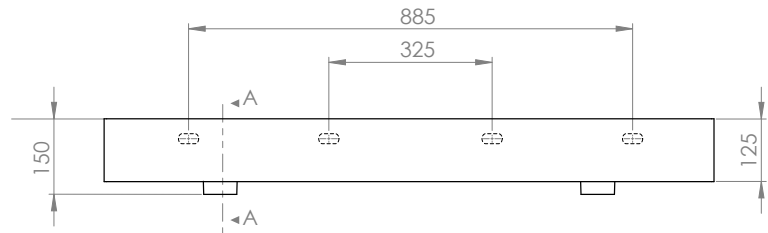

Side

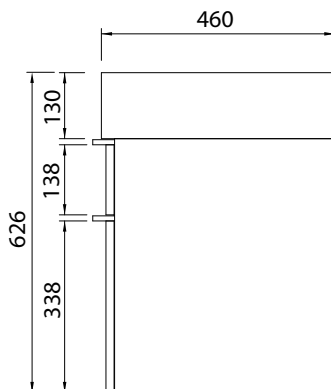

Front

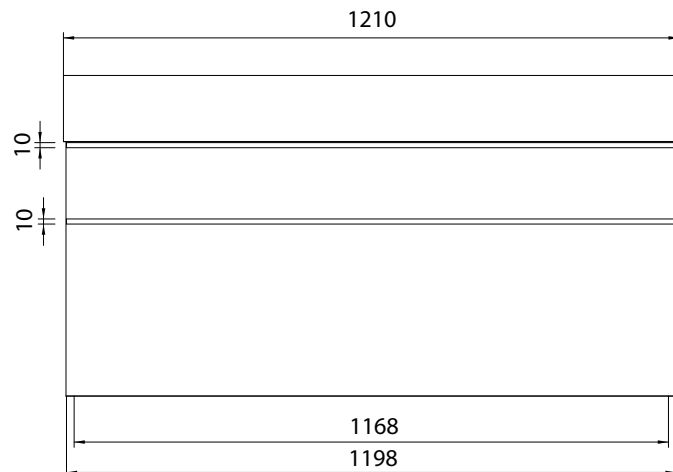

NOTES

Waste cut out in top drawer only. Drawing indicates the technical measurement only and is not a reflection of how the unit will look. Sizes approximate. All drawings in millimeters. Drawings not to scale.