

## DESCRIPTION

Twenty 1010 Wall Hung, 2 Drawer, White / Timber Veneer

## PRODUCT CODE

TW101D2WH / T



## FEATURES

- W1010 x H626 x D480 mm
- Available painted White, in Timber Veneer\*, or in your choice of paint colour.^
- The paint used on our products is polyurethane or UV based. It is five times harder and more durable than lacquer finishes.
- Timber veneer finishes are 100% natural, so each have variations in grain and colour. All come stained and sealed with a protective UV finish.
- Four bowl options – left, right, centre and total.
- Handles available in White Oak, Natural Oak or Dark Oak timber veneers.
- Soft-close drawers.
- Italian-made, ceramic top. NZ-made cabinetry.

## PAINT / TIMBER VENEER FINISHES\*



White Paint



White Oak



Blonde Oak



Natural Oak



Walnut

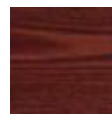

Chestnut



Coffee

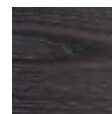

Noce



Dark Oak

## NOTES

Please see reverse for technical drawings.

\*Non-stock item. ^15% surcharge applies for custom paint colour, 25% for metallic and black gloss.

## DESCRIPTION

Twenty 1010 Wall Hung, 2 Drawer, White / Timber Veneer, Left Bowl

## PRODUCT CODE

TW101D2WHLH / TW101D2WHTLH

## TECHNICAL DRAWINGS

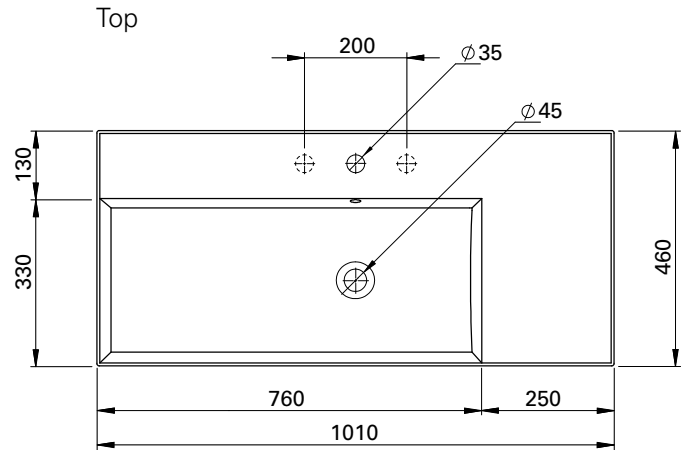

Section AA: Side of Basin

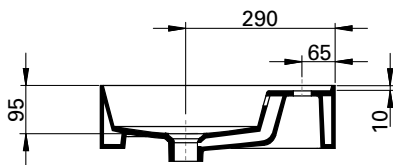

Back of Basin

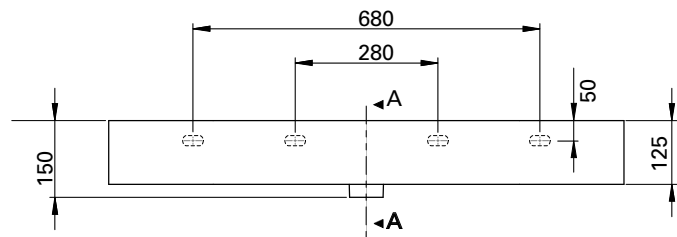

Side

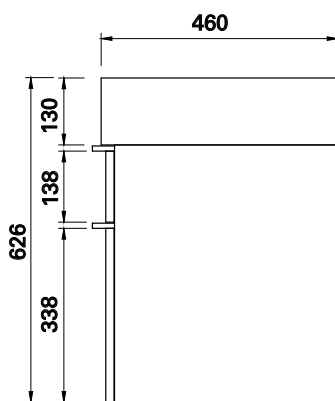

Front

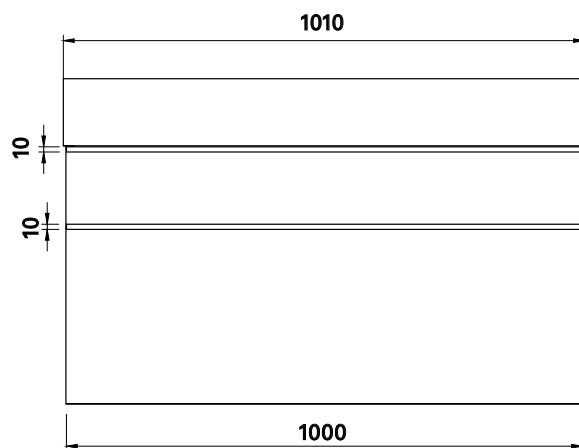

## NOTES

Waste cut out in top drawer only. Drawing indicates the technical measurement only and is not a reflection of how the unit will look. Sizes nominal only. All drawings in millimeters. Drawings not to scale.