

DESCRIPTION

Splash 600 Floor-Standing Vanity, 2 Drawers, White / Melamine

PRODUCT CODE

SP60D2FL / SP60D2FLM



FEATURES

- Dimensions: W600 x H900 x D450 mm
- Available in White paint (Gloss) or Melamine*
- The paint used on our products is polyurethane based. It is five times harder and more durable than lacquer finishes.
- Timber Effect Melamine: Our wood grain melamine is a low-pressure laminate.
- Polymarble basin (acrylic)
- Soft-close drawer/s
- Comes with the Box Handle (H1), other handle options include the Mini Semi Handle (H4), Semi Handle (H2), or Semi Anodized Black Handle (H2-BK).
- Made to order in NZ.

MELAMINE / PAINT FINISHES



MNA
Nordic Ash



MDF
Driftwood

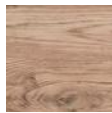

MFO
French Oak



MME
Manhattan
Elm



MSO
Southern
Oak



MHW
Hickory
Walnut

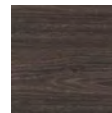

MBF
Black Forest



MCO
Charred Oak



No Code
White Paint
(Gloss)

TECHNICAL DRAWINGS

See following page.

NOTES

- *Made to order in NZ.
- Must use bottle traps to ensure drawers open, we recommend 40551-32 bottle trap.
- Please use a contoured waste with all basins, we recommend PUW68R (slotted, for basins with overflow) or W22 (unslotted, for basins with no overflow) wastes.
- March 2020.

DESCRIPTION

Splash 600 Floor-Standing Vanity, 2 Drawers, White / Melamine

PRODUCT CODE

SP60D2FL / SP60D2FLM

TECHNICAL DRAWINGS

Top

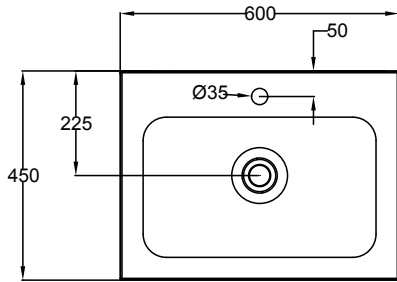

Front Section of Basin

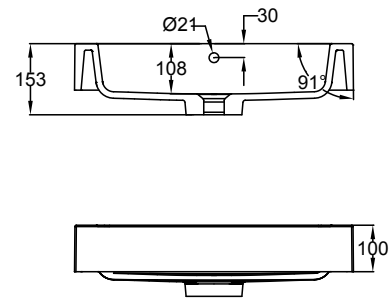

Front

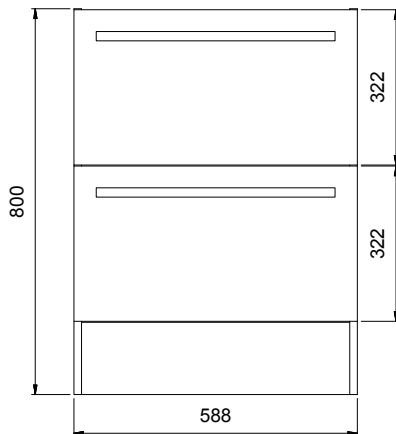

Side

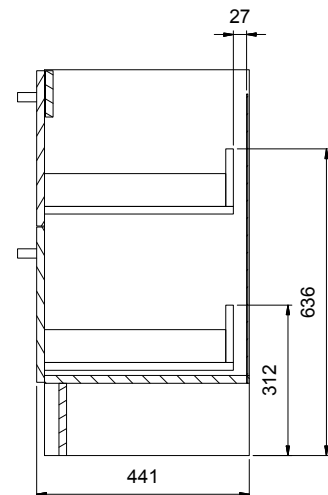

Top Section of Drawer

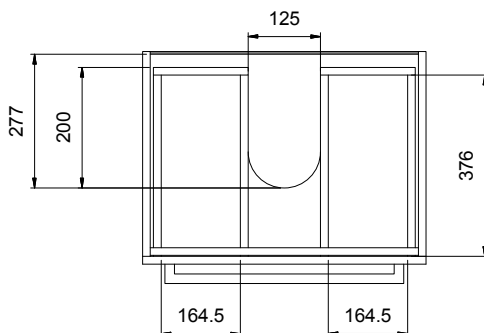

NOTES

- Drawing indicates the technical measurement only and is not a reflection of how the unit will look.
- Sizes are nominal only.
- All drawings in millimeters.
- Drawings not to scale.
- March 2020.