

DESCRIPTION

Moode 1800 Wall Hung Vanity - 4 Drawers, Double Bowl, White / Timber Veneer

PRODUCT CODE

MD180D4DB / MD180D4DBTA



FEATURES

- Dimensions - W 1780 x H 615 x D 500mm
- Available painted White (Gloss), in Timber Veneer,* or Custom Colour paint.**
- The paint used on our products is polyurethane or UV based.
- Timber veneer finishes are 100% natural, so each has variations in grain and colour. All come stained and sealed with a protective UV finish.
- Kordura tops** are a standard (25mm) thickness.
- Soft-close drawers. NZ-made cabinetry.
- Pair with our one of our Undermount, Semi-Recessed or Counter Top basins.

PAINT / TIMBER VENEER* FINISHES

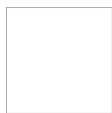

White Paint



White Oak



Blonde Oak



Natural Oak



Walnut

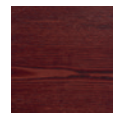

Chestnut



Coffee

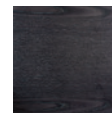

Noce

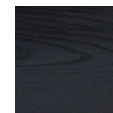

Dark Oak



Custom Paint
(Gloss/Matte)**

KORDURA TOP FINISHES**



White



Carrara
Marble

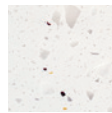

Ice
Crystal



Ariston

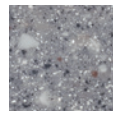

Peak
Stone

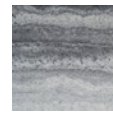

Akashi Grey

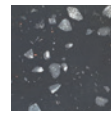

Black
Granite

TECHNICAL DRAWINGS

See reverse.

NOTES

• *Non-stock item. • **Additional cost** applies for Custom paint colour • 50/50 Custom paint colour/Timber Veneer only available on 1500 + 1800 vanities (side-by-side). For basin options refer to the Michel César catalogue • Inset and Glory Undermount basins not available with 600 Vanities • 1500 + 1800mm vanities with single bowls must be offset left or right.

****KORDURA TOPS** • **Additional cost** applies for coloured Kordura tops (excludes White). • Tapholes do not come pre-drilled – this is the responsibility of the installer, and can be cut with a hole saw, jigsaw or router. October 2022.

DESCRIPTION

Moode 1800 Wall Hung Vanity - 4 Drawers, Double Bowl, White / Timber Veneer

PRODUCT CODE

MD180D4DB / MD180D4DBTA

TECHNICAL DRAWINGS

Top

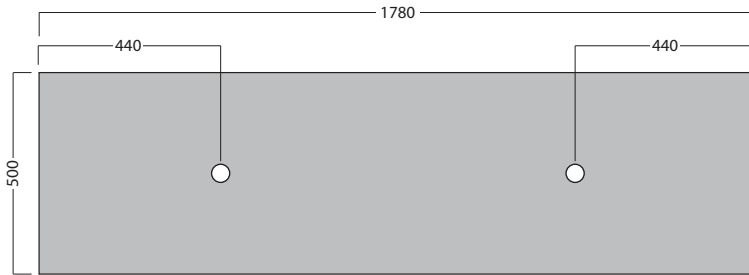

Front

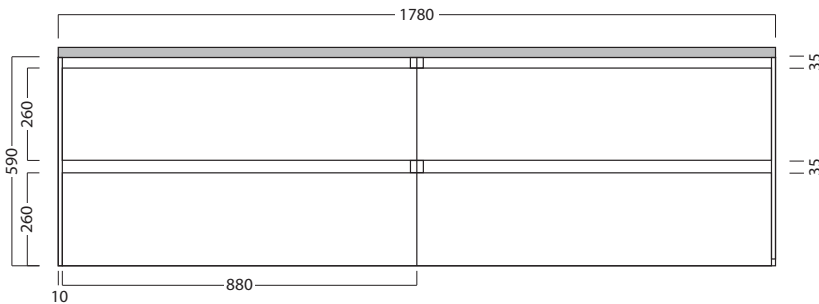

Side Section

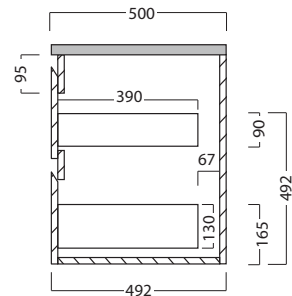

Top Section of Drawer

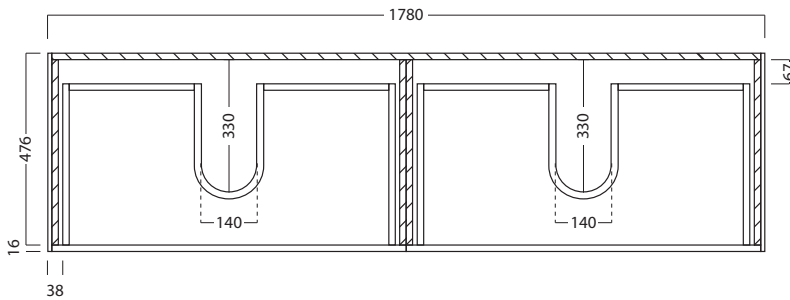

NOTES

Drawing indicates the technical measurement only and is not a reflection of how the unit will look. Sizes are nominal only. All drawings in millimeters. Drawings not to scale.