

## DESCRIPTION

Moode 1200 Wall Hung Vanity - 1 Drawer, White / Timber Veneer

## PRODUCT CODE

MD120D / MD120DTA



## FEATURES

- Dimensions - W 1200 x H 400 x D 500mm
- Available painted White (Gloss), in Timber Veneer,\* or Custom Colour paint.\*\*
- The paint used on our products is polyurethane or UV based.
- Timber veneer finishes are 100% natural, so each has variations in grain and colour. All come stained and sealed with a protective UV finish.
- Kordura tops\*\* are a standard (25mm) thickness.
- Soft-close drawers. NZ-made cabinetry.
- Pair with our one of our Undermount, Semi-Recessed or Counter Top basins.

## PAINT / TIMBER VENEER\* FINISHES



White Paint



White Oak



Blonde Oak



Natural Oak



Walnut



Chestnut



Coffee

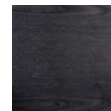

Noce

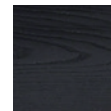

Dark Oak



Custom Paint  
(Gloss/Matte)\*\*

## KORDURA TOP FINISHES\*\*

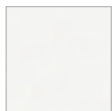

White



Carrara  
Marble



Ice  
Crystal



Ariston

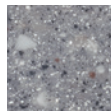

Peak  
Stone

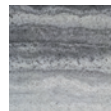

Akashi Grey

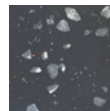

Black  
Granite

## TECHNICAL DRAWINGS

See reverse.

## NOTES

• \*Non-stock item. • **Additional cost** applies for Custom paint colour • 50/50 Custom paint colour/Timber Veneer only available on 1500 + 1800 vanities (side-by-side). For basin options refer to the Michel César catalogue • Inset and Glory Undermount basins not available with 600 Vanities • 1500 + 1800mm vanities with single bowls must be offset left or right.

\*\***KORDURA TOPS** • **Additional cost** applies for coloured Kordura tops (excludes White). • Tapholes do not come pre-drilled – this is the responsibility of the installer, and can be cut with a hole saw, jigsaw or router. October 2022.

## DESCRIPTION

Moode 1200 Wall Hung Vanity - 1 Drawer, White / Timber Veneer

## PRODUCT CODE

MD120D / MD120DTA

## TECHNICAL DRAWINGS

Top



 Standard (S) - 25mm

Front

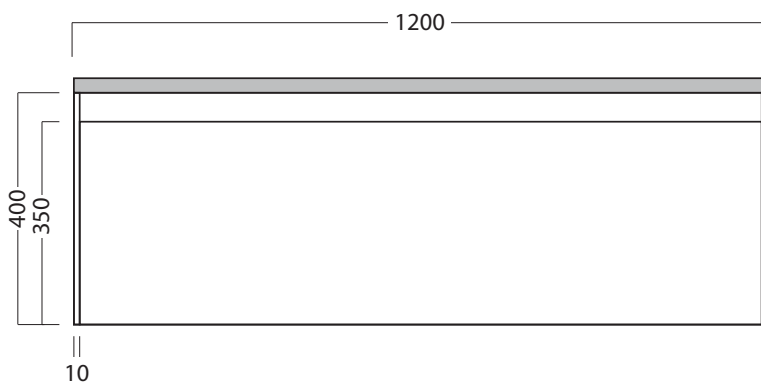

Side Section

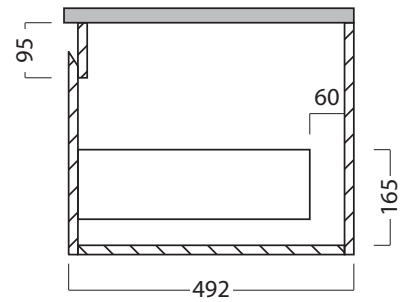

Top Section of Drawer

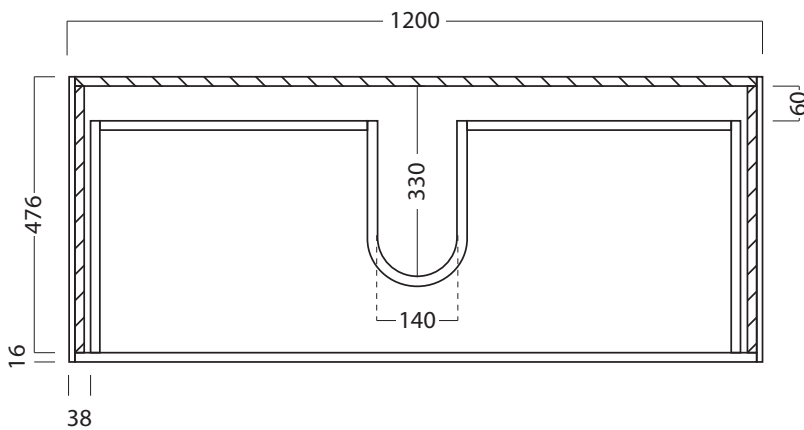

## NOTES

Drawing indicates the technical measurement only and is not a reflection of how the unit will look. Sizes are nominal only. All drawings in millimeters. Drawings not to scale.