

Milan

vcbc

DESCRIPTION

Milan Wall-Faced Toilet Suite

PRODUCT CODE

15.B.35308



FEATURES

- Dimensions - W360 x H420 x D530 mm
- Rimless Wall-Faced toilet suite
- Toilet suite includes soft close seat, lid, and floor fixings
- Vitreous china with Nano Glaze bowl – helps keep ceramic stay cleaner for longer
- Removable soft close seat with stainless steel hinges.
- P-Trap pan, and comes with S-Trap Connector (284.M.30846).
- Rated 4 stars WELS (3/4.5L water flush use)

TECHNICAL DRAWINGS

Top

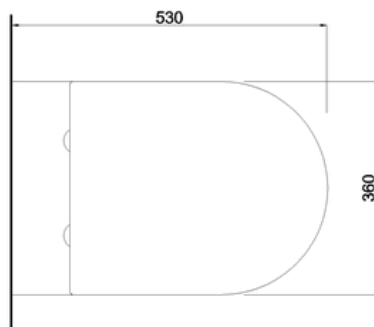

Side Section

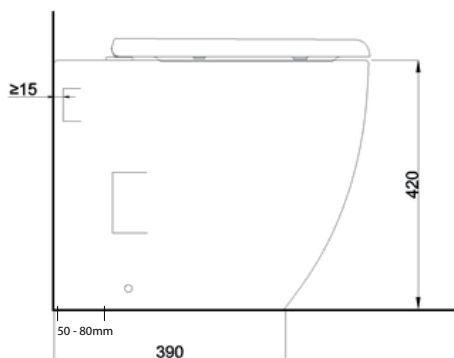

Back

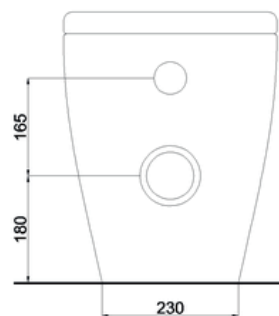

NOTES

Set out for the S Pan can extend on an STC S-Trap Connector from 100 - 265mm. Drawing indicates the technical measurement only and is not a reflection of how the unit will look. Sizes are nominal only. All drawings in millimeters. Drawings not to scale. November 2022.

Flush Plates

vcbc

DESCRIPTION

Round Flush Plates, White / Chrome High Gloss / Chrome Matte / Black

PRODUCT CODE

3D1.1106 / 3D1.1010
3D1.1008 / K5130-23



FEATURES

- Dimensions - W236 x H152 x D8 mm
- Round flush plates for in-wall cisterns

FINISHES

All finishes have Chrome Gloss Button Trim

- White Gloss (3D1.1106)
- Chrome Gloss* (3D1.1010)
- Chrome Matte* (3D1.1008)
- Black Matte* (K5130-23)

TECHNICAL DRAWINGS

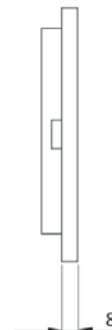
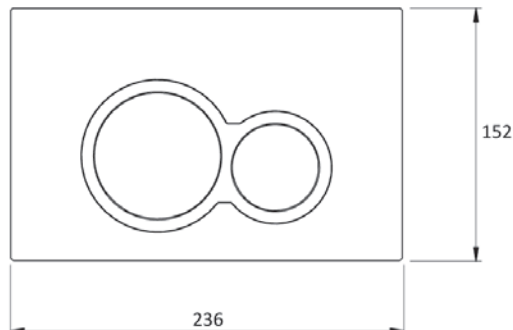

NOTES

*Additional cost. Drawing indicates the technical measurement only and is not a reflection of how the product will look. Sizes nominal only. Drawings in millimeters, not to scale. August 2023.

Flush Plates

vcbc

DESCRIPTION

Rectangle Flush Plates, White / Chrome High Gloss / Chrome Matte / Black

PRODUCT CODE

3D1.1009/3D1.1010
3D1.1011/K5131-23



FEATURES

- Dimensions - W236 x H152 x D8 mm
- Rectangle flush plates for in-wall cisterns

FINISHES

All finishes have Chrome Gloss Button Trim

- White Gloss (3D1.1009)
- Chrome Gloss* (3D1.1010)
- Chrome Matte* (3D1.1011)
- Black Matte* (K5131-23)

TECHNICAL DRAWINGS

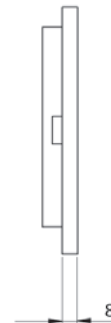
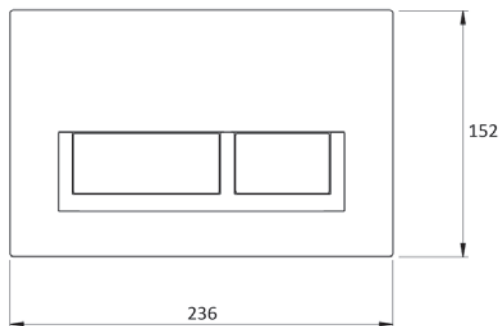

NOTES

*Additional cost. Drawing indicates the technical measurement only and is not a reflection of how the product will look. Sizes nominal only. Drawings in millimeters, not to scale. August 2023.