

## DESCRIPTION

Moode 1000 Wall Hung Vanity - 1 Drawer, White / Timber Veneer

## PRODUCT CODE

MD100D /  
MD100DTA



## FEATURES

- Dimensions - W 1000mm x H 400mm x D 492mm
- Available painted White, in Timber Veneer\*, or in your choice of paint colour.^
- The paint used on our products is polyurethane or UV based. It is five times harder and more durable than lacquer finishes.
- Timber veneer finishes are 100% natural, so each have variations in grain and colour. All come stained and sealed with a protective UV finish.
- Kordura tops available in Fine (12.6mm), Standard (25mm) or Deep (70mm) thickness, in White, or coloured Kordura tops.\*\*
- Soft-close drawers.
- NZ-made cabinetry.
- Goes with most basins.

## PAINT / TIMBER VENEER FINISHES\*



White Paint



White Oak



Blonde Oak



Natural Oak



Walnut

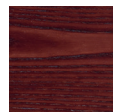

Chestnut



Coffee

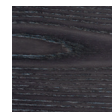

Noce



Dark Oak

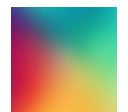

Custom Paint^

## KORDURA TOP FINISHES\*\*



White

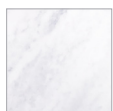

Carrera  
Marble

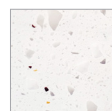

Ice Crystal

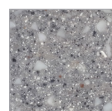

Peak Stone

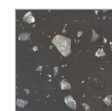

Black Granite

## NOTES

Please see following page for technical drawings.

\*Non-stock item. \*\*15% surcharge applies for coloured Kordura tops. ^15% surcharge applies for custom paint colour, 25% for metallic and black gloss. Tapholes do not come pre-drilled – this is the responsibility of the installer, and can be cut with a hole saw, jigsaw or router.

**DESCRIPTION**

Moode 1000 Wall Hung Vanity - 1 Drawer, White / Timber Veneer

**PRODUCT CODE**

MD100D /  
MD100DTA

**TECHNICAL DRAWINGS**

Top

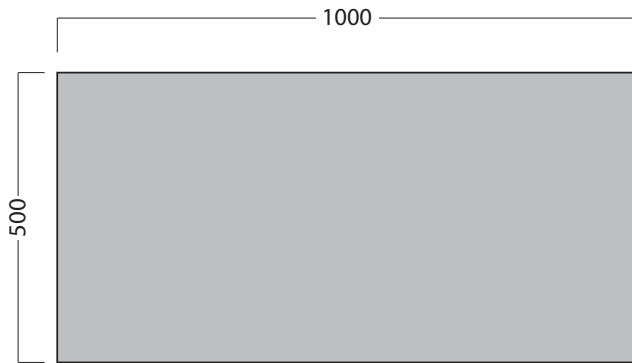

Kordura Top available in 3 thickness

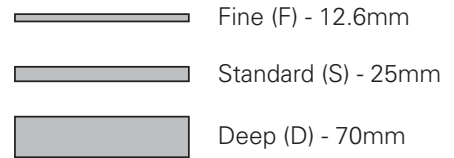

Front

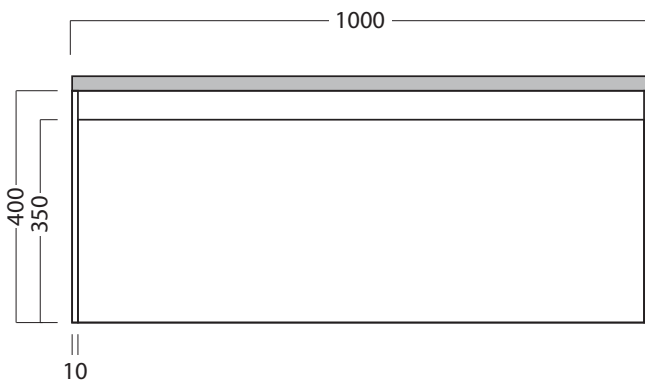

Side Section

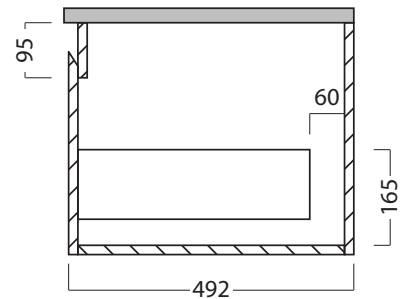

Top Section of Drawer

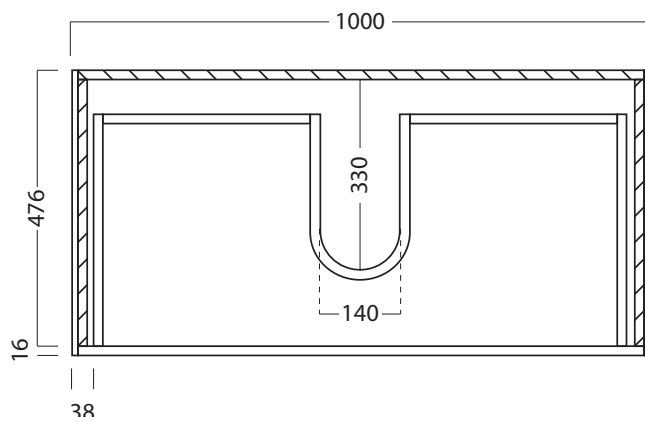

**NOTES**

Drawing indicates the technical measurement only and is not a reflection of how the unit will look. Sizes are nominal only. All drawings in millimeters. Drawings not to scale.