

1200 HOROI CABINET

LAUNDRY

DESCRIPTION

1200 Laundry Cabinet, Horoi Stainless Steel Top, 2 Drawers, Timber Veneer

PRODUCT CODE

LUS120ST



FEATURES

- Dimensions - W 1200mm x H 920mm x D 600mm
- Available in White, Timber Veneer*, or your choice of paint colour^ (surcharge applies).
- Kordura tops 25mm thick, available in White, or coloured Kordura tops (10% surcharge applies).
- Unit comes with a tub, cabinet and soft-close drawers.
- Pair it with a Lancashire, Stainless Steel, or Inset tub (surcharges applies).
- Overhang options also available in left-, right-hand or both side. Custom size available upon request (surcharges applies).
- Our Timber Veneer finishes are 100% natural, so each have variations in grain and colour. All come stained and sealed with a protective UV finish.

PAINT / TIMBER VENEER FINISHES*



White Oak



Blonde Oak

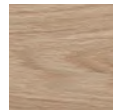

Natural Oak



Walnut



Chestnut

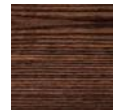

Coffee



Noce



Dark Oak



Custom
Paint Colour^

NOTES

*Non-stock item. **10% surcharge applies for coloured Kordura tops. ^15% surcharge applies for custom paint colour, 25% for metallic and black gloss. Tapholes do not come predrilled – this is the responsibility of the installer, and can be cut with a hole saw. See reverse page for technical drawings.

1200 HOROI CABINET

LAUNDRY

DESCRIPTION

1200 Laundry Cabinet, Horoi Stainless Steel Top, 2 Drawers, Timber Veneer

PRODUCT CODE

LUS120ST

TECHNICAL DRAWINGS

Top

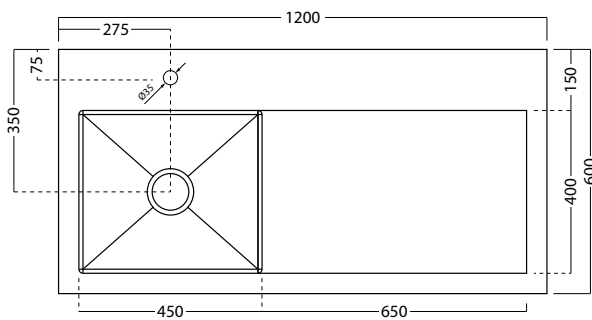

Front

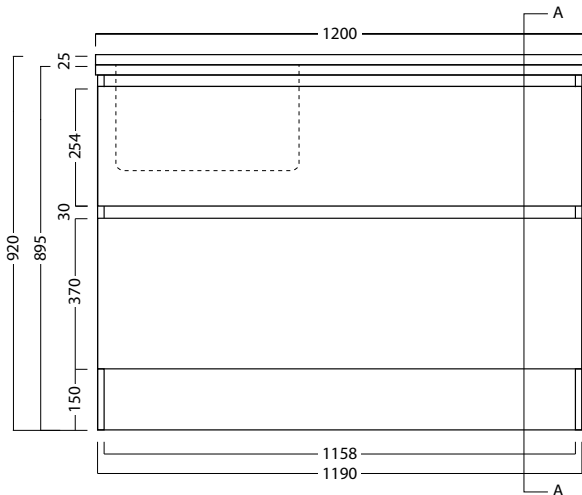

Side Section AA

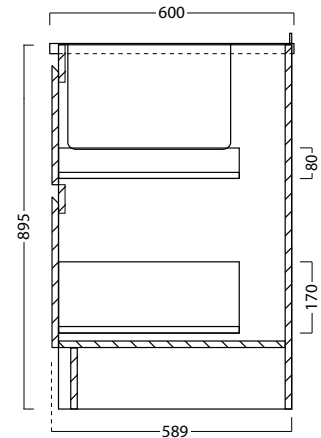

Top Section of Drawer

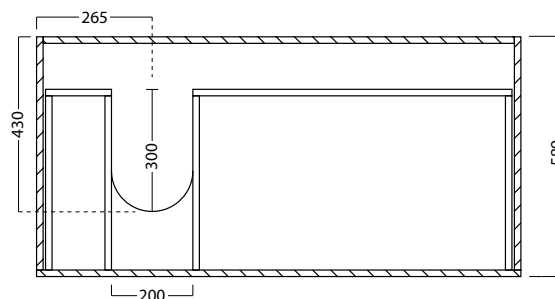

NOTES

Drawing indicates the technical measurement only and is not a reflection of how the unit will look. Sizes approximate. All drawings in millimeters. Drawings not to scale.