

Grandangolo /

Michel César

DESCRIPTION

Grandangolo 750 - 2 Drawer, Right Side Bowl

PRODUCT CODE

GD75D2SX / GD75D2SXT / GD75D2SXCC



FEATURES

- Dimensions - W750 x H570 x D500 mm
- Available in White Gloss paint, Custom Colour paint or Timber Veneer.
- Features a ceramic top with integrated basin in white.
- The paint used on our products is polyurethane or UV based. Is harder and more durable than lacquer finishes.
- Timber Veneer finishes are 100% natural, with variations in grain and colour. All come stained and sealed with a protective UV finish.
- NZ-made cabinetry.

FINISHES

White Gloss Paint / Custom Colour Paint



White Gloss



Custom Paint

Timber Veneer



White Oak



Blonde Oak

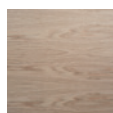

Natural Oak



Walnut

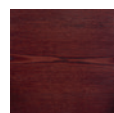

Chestnut



Coffee

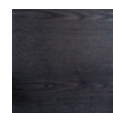

Noce



Dark Oak

Please see reverse for technical drawings and measurements.

NOTES

See our website for product prices. Drawing indicates the technical measurement only and is not a reflection of how the product will look. Sizes are nominal only. All drawings in millimeters. Drawings not to scale. April 2023.

DESCRIPTION

Grandangolo 750 - 2 Drawer, Right Side Bowl

PRODUCT CODE

GD75D2SX / GD75D2SXT / GD75D2SXCC

TECHNICAL DRAWINGS

Top

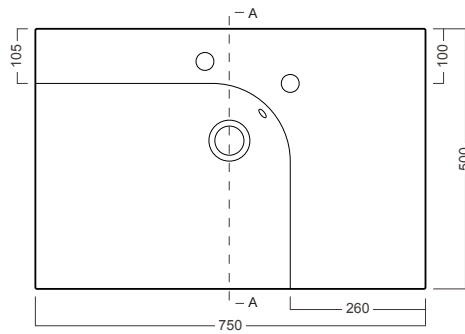

Side Section

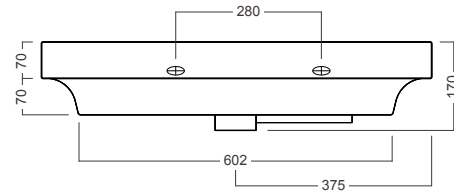

Front

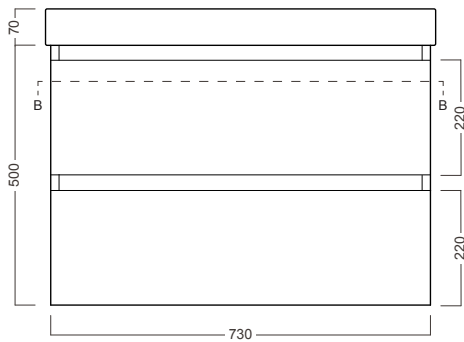

Side Section

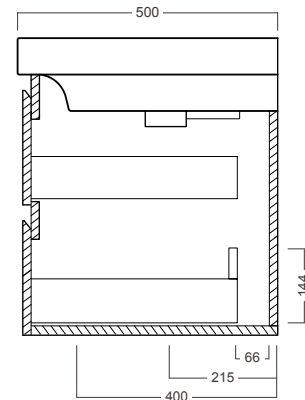

Drawer Cross Section

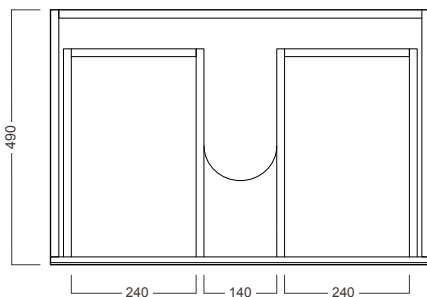

NOTES

See our website for product prices. Drawing indicates the technical measurement only and is not a reflection of how the product will look. Sizes are nominal only. All drawings in millimeters. Drawings not to scale. April 2023.