

GRANDANGOLO BOX

Michel César

DESCRIPTION

500 Package - 1000 Basin, Towel Rail & 500 Box, 1 Drawer + 1 Concealed Drawer, White / Timber Veneer

PRODUCT CODE

GB50/100DX /
GB50/100DXT



FEATURES

- Dimensions - W 1000 x H 400 x D 500mm
- Available in White paint (Gloss or Matt[^]), Timber Veneer,* or in your choice of paint colour.*[^]
- The paint used on our products is polyurethane or UV based. It is five times harder and more durable than lacquer finishes.
- Timber veneer finishes are 100% natural, so each have variations in grain and colour. All come stained and sealed with a protective UV finish. Gloss option is available for most veneers.
- Soft-close drawer runners.
- Made to order in NZ.
- Italian-made basin with overflow (YOVA01).

PAINT[^] / TIMBER VENEER* FINISHES



No Code
White Paint
(Gloss or Matt)



TWO
White Oak

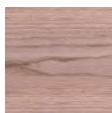

TBO
Blonde Oak

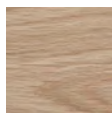

TNO
Natural Oak

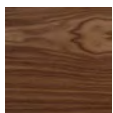

TW
Walnut

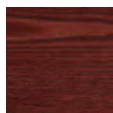

TCH
Chestnut

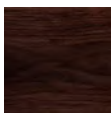

TC
Coffee

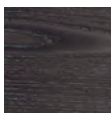

TN
Noce



TDO
Dark Oak



Custom Paint
(Gloss or Matt)

TECHNICAL DRAWINGS

Back

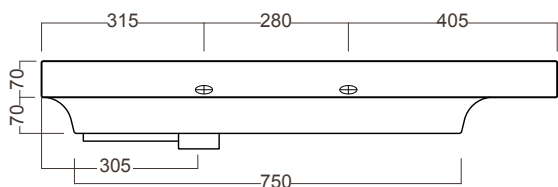

Side

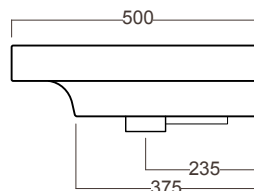

Top

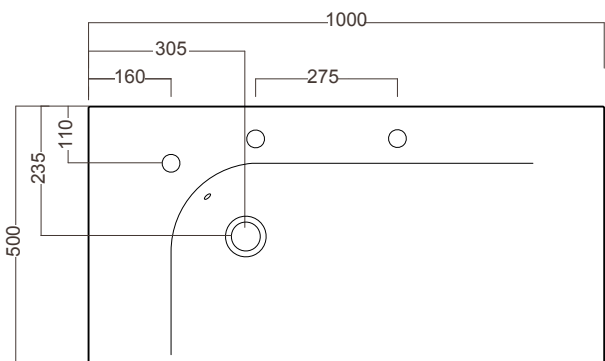

Towel Rail - Top

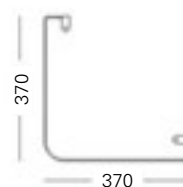

NOTES

See following page.

GRANDANGOLO BOX

Michel César

DESCRIPTION

500 Package - 1000 Basin, Towel Rail & 500 Box, 1 Drawer + 1 Concealed Drawer, White / Timber Veneer

PRODUCT CODE

GB50/100DX /
GB50/100DXT

TECHNICAL DRAWINGS

Top

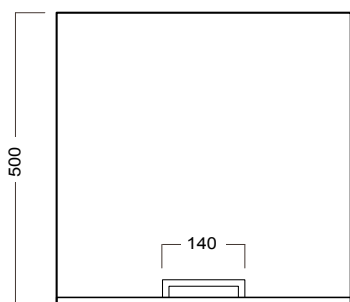

Front

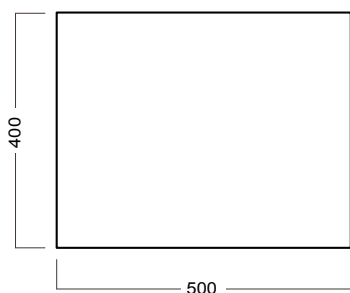

Side Section

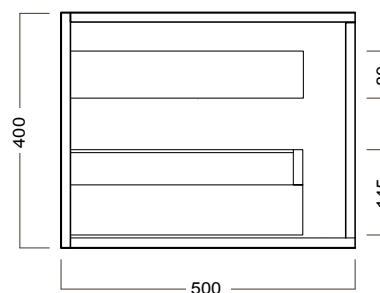

Top Section of Drawer

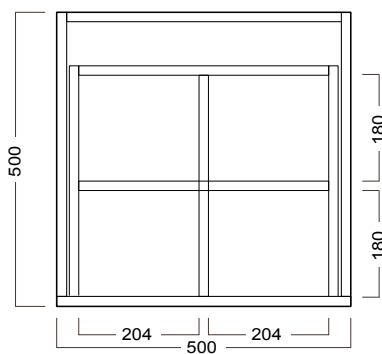

NOTES

- *Non-stock item. • ^15% surcharge applies on Custom paint colours (Gloss/Matt), and Matt White paint finish, 25% for Metallic and Black (Gloss/Matt).
- Must use a contoured waste with all basins, we recommend PUW68R (slotted, for basins with overflow). • When ordering please let us know if you're placing the basin directly on top of the Box, so that we can make the cabinet fit. • See basin technical drawings for tap hole options and specify which holes you would like punched out, if any. • Drawing indicates technical measurement only and is not a reflection of how the product will look. Sizes nominal only. Drawings in millimetres. Not to scale. April 2020.