

ERIKA PRO

Michel César

DESCRIPTION

Erika Pro 550 Wall-Hung Vanity, 1 Drawer, White / Timber Veneer

PRODUCT CODE

E55WH / E55WHT



FEATURES

- Dimensions - W 550 x H 465 x D 400 mm
- Available painted White, in Timber Veneer*, or in your choice of paint colour.^
- The paint used on our products is polyurethane or UV based. It is five times harder and more durable than lacquer finishes.
- Timber veneer finishes are 100% natural, so each have variations in grain and colour. All come stained and sealed with a protective UV finish.
- Soft-close drawers.
- Italian-made, ceramic top. NZ-made cabinetry.

PAINT / TIMBER VENEER FINISHES*



White Paint



White Oak



Blonde Oak



Natural Oak



Walnut



Chestnut

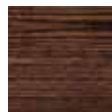

Coffee



Noce



Dark Oak

NOTES

Please see reverse for technical drawings.

*Non-stock item. ^15% surcharge applies for custom paint colour, 25% for metallic and black gloss.

MICHEL CÉSAR
VCBC
BURLINGTON
LAUNDRY

/ WHERE BATHROOMS
& LAUNDRIES
COME TOGETHER
BEAUTIFULLY /

info@smail.co.nz
bathco.co.nz

4-8 Ace Place
Kingsland
Auckland 1021
New Zealand

P +64 9 309 9109
F +64 9 309 9343

86 Wigram Road
P.O. Box 8644
Christchurch 8025
New Zealand

P +64 3 343 0969
F +64 3 343 0967

BATH/
CO/

DESCRIPTION

Erika Pro 550 Wall-Hung Vanity, 1 Drawer, White / Timber Veneer

PRODUCT CODE

E55WH / E55WHT

TECHNICAL DRAWINGS

Top

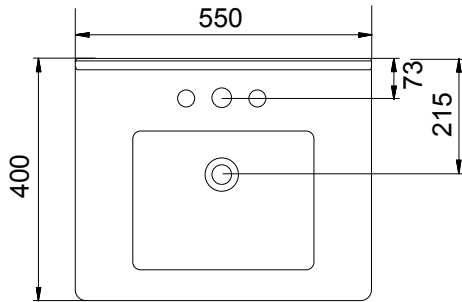

Back

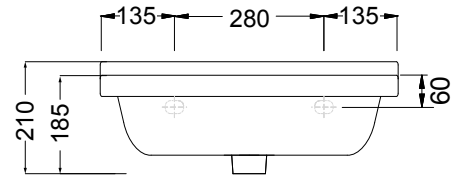

Front

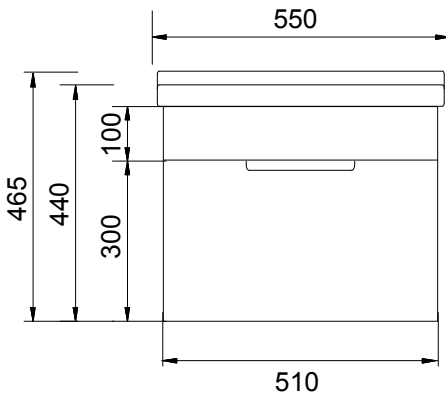

Side Section

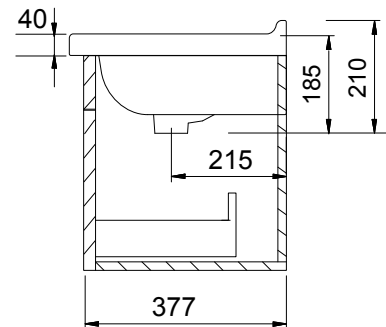

Top Section of Drawer

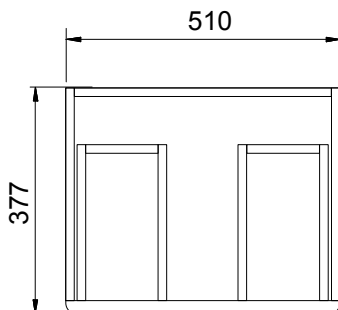

NOTES

Drawing indicates the technical measurement only and is not a reflection of how the unit will look. Sizes are nominal only. All drawings in millimeters. Drawings not to scale.