

Central Shower

vcbc

DESCRIPTION

Central Alcove Shower Package - 1200mm Door

PRODUCT CODE

CT12903



FEATURES

- Dimensions - W1200 x H1950 x D900mm
- Door Entry - W480mm
- Signature roller system using smooth gliding wheels.
- Polished chrome finish fittings.
- 8mm clear toughened safety glass with 3M Ultimate Glass Protection System.
- Powershower proof – Shower screens have been carefully developed and tested to ensure they can withstand the optimum performance of a power shower.
- 20 - 30mm adjustment for easy fitting.
- Reversible design for left or right opening.
- Package includes 1200mm single door, shower tray (BSF-1290S) with upstands, 3-sided wall liner, easy clean waste and glue pack.

TECHNICAL DRAWINGS

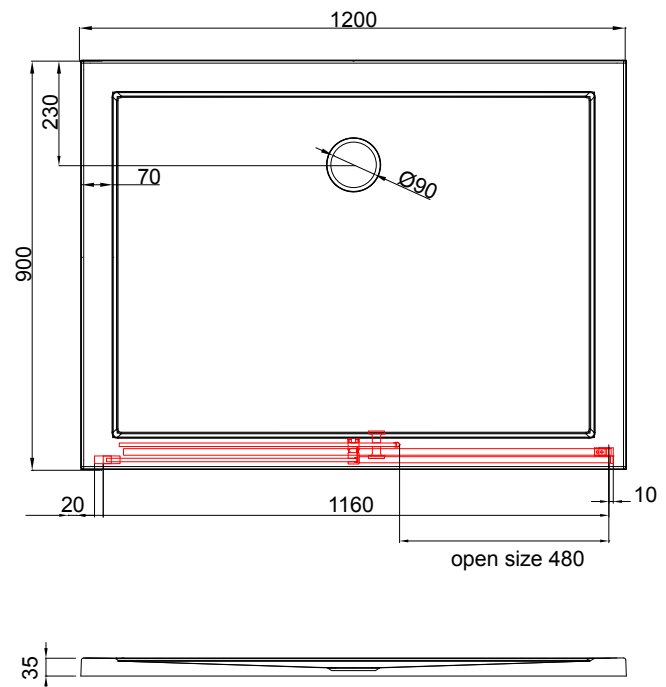
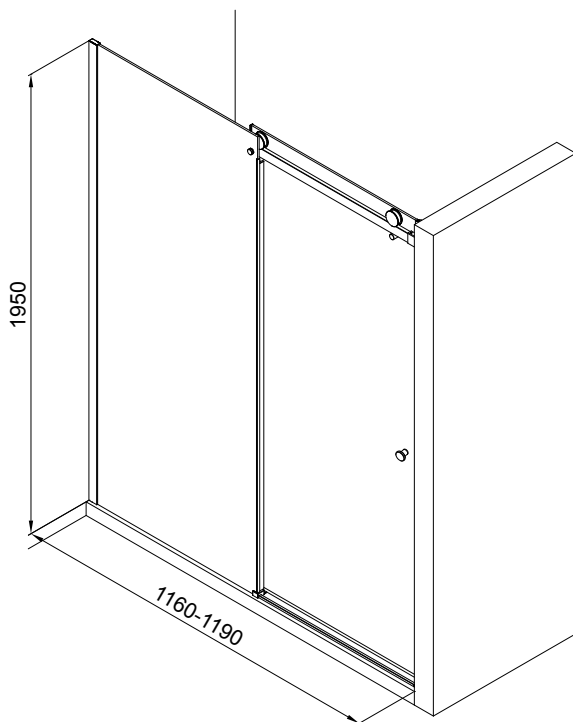

*30mm adjustment for easy fitting per panel

NOTES

Excludes tap ware & accessories. Wall liners are custom-made and are only supplied after wall-to-wall GIB measurements have been provided. Drawing indicates the technical measurement only and is not a reflection of how the unit will look. Sizes are nominal only. All drawings in millimeters. Drawings not to scale. October 2019.