

Acrylic Shower Tray

vcbc

DESCRIPTION

Rectangle Shower Tray - 1700 x 1000

PRODUCT CODE

1B2.1343



FEATURES

- Dimensions - W1700mm x H35mm x D1000mm
- Lightweight anti-bacterial acrylic shower tray designed with the best quality materials and a contemporary look.
- Designed to suit a range of shower configurations and enclosures, these superior slimline trays are built to last with impeccable strength.
- Comes with an easy clean waste, sealing tape and acrylic upstands on two sides.
- All trays are reinforced with a steel frame and then filled with foam to reduce "creaks".
- 90mm waste diameter
- Underside of tray pre-marked for fitting of feet

TECHNICAL DRAWINGS

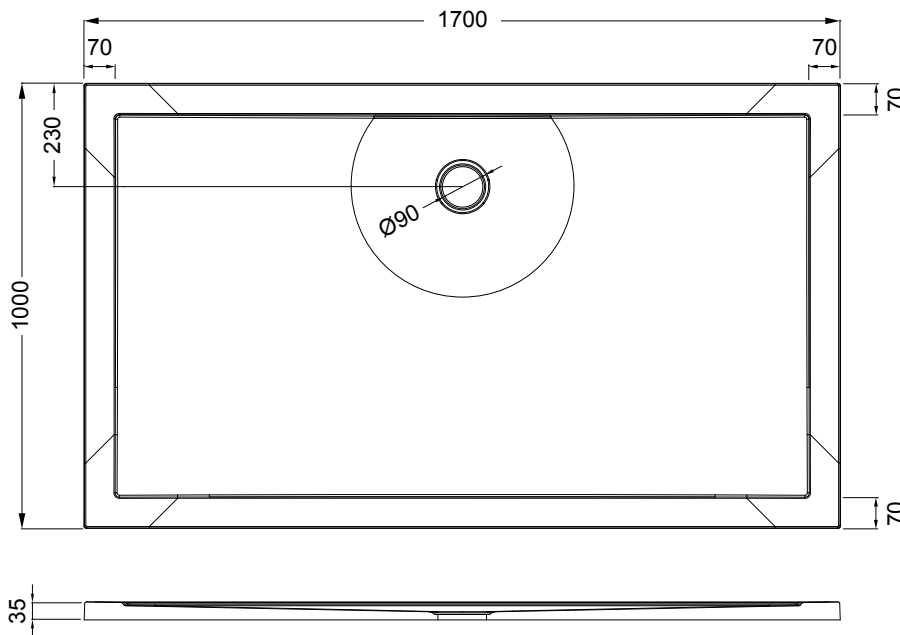

NOTES

Drawing indicates the technical measurement only and is not a reflection of how the unit will look. Sizes are nominal only. All drawings in millimeters. Drawings not to scale.

MICHEL CÉSAR
VCBC
BURLINGTON
LAUNDRY

/ WHERE BATHROOMS
& LAUNDRIES
COME TOGETHER
BEAUTIFULLY /
info@smail.co.nz
bathco.co.nz

4-8 Ace Place
Kingsland
Auckland 1021
New Zealand

P +64 9 309 9109
F +64 9 309 9343

86 Wigram Road
P.O. Box 8644
Christchurch 8025
New Zealand

P +64 3 343 0969
F +64 3 343 0967

BATH/
CO/