

# Acrylic Shower Tray

vcbc

## DESCRIPTION

Rectangle Shower Tray - 1700 x 900

## PRODUCT CODE

1B2.1342



## FEATURES

- Dimensions - W1700mm x H35mm x D900mm
- Lightweight anti-bacterial acrylic shower tray designed with the best quality materials and a contemporary look.
- Designed to suit a range of shower configurations and enclosures, these superior slimline trays are built to last with impeccable strength.
- Comes with an easy clean waste, sealing tape and acrylic upstands on two sides.
- All trays are reinforced with a steel frame and then filled with foam to reduce "creaks".
- 90mm waste diameter
- Underside of tray pre-marked for fitting of feet

## TECHNICAL DRAWINGS

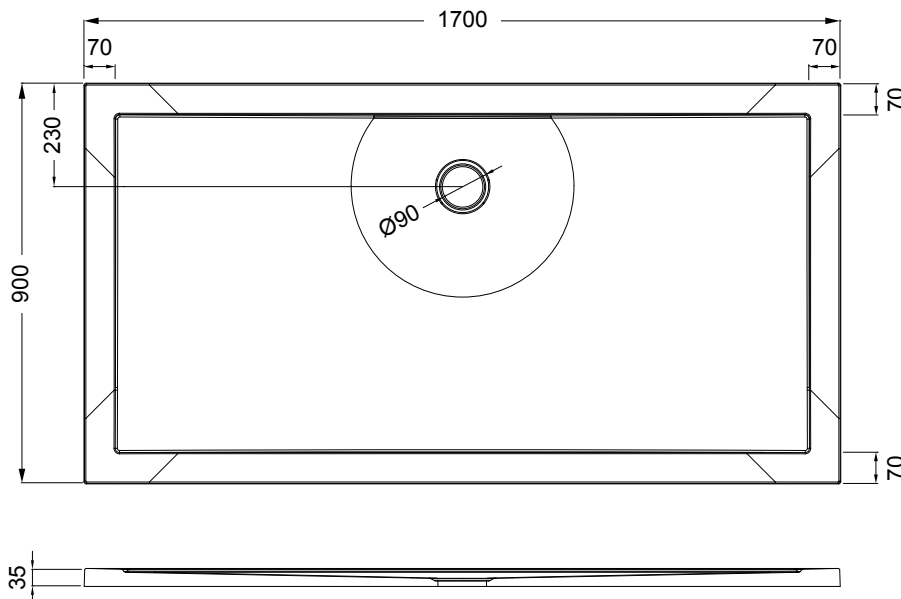

## NOTES

Drawing indicates the technical measurement only and is not a reflection of how the unit will look. Sizes are nominal only. All drawings in millimeters. Drawings not to scale.

**MICHEL CÉSAR**  
**VCBC**  
**BURLINGTON**  
**LAUNDRY**

/ WHERE BATHROOMS  
& LAUNDRIES  
COME TOGETHER  
BEAUTIFULLY /  
info@smail.co.nz  
bathco.co.nz

4-8 Ace Place  
Kingsland  
Auckland 1021  
New Zealand

P +64 9 309 9109  
F +64 9 309 9343

86 Wigram Road  
P.O. Box 8644  
Christchurch 8025  
New Zealand

P +64 3 343 0969  
F +64 3 343 0967

**BATH/**  
**CO/**