

OVAL MATTE BATHS

vcbc

DESCRIPTION

Oval 1700 Matte Freestanding Acrylic Bath

PRODUCT CODE

15.A.40135



Dimensions	W 1700 x H 600 x D 780 (mm)
Material	Acrylic (White Matte Finish)
Weight	43kg
Water Capacity	250L*
Displaced Capacity	180L**
Included	Overflow and pop-up waste
Features	<ul style="list-style-type: none">• An acrylic composition with excellent thermal properties, Oval is able to retain heat and is warm to touch.• Free-standing, double-ended design with thin edge and smooth curved corners.• Matte finish

TECHNICAL DRAWINGS

Side

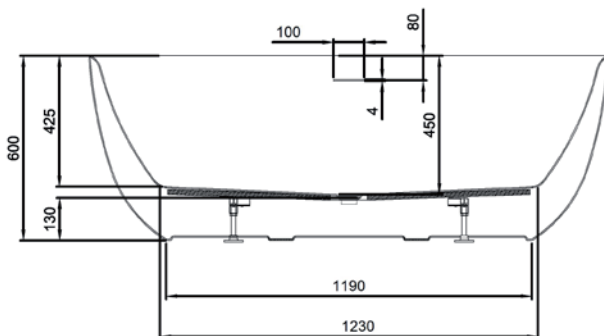

Front

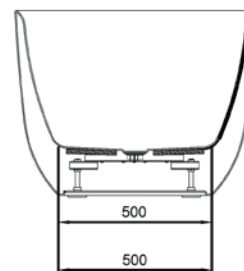

Top Down

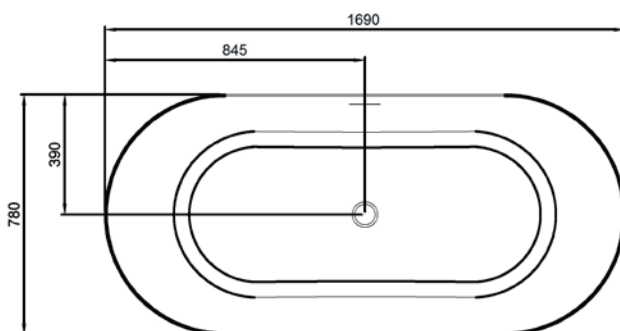

NOTES

*Volume of water contained in the bath if filled to the overflow. **Volume of water contained in the bath if filled to the overflow, less 70 litres to allow for an average-sized person in the bath. Drawing indicates the technical measurement only and is not a reflection of how the product will look. Sizes are nominal only. All drawings in millimeters. Drawings not to scale. April 2024.